

cranes & access

April/May 2023 Vol.25 issue 2

www.vertikal.net



**CRAWLER
CRANES**

**VEHICLE
MOUNTED LIFTS**

CONEXPO REVIEW

VERTIKAL DAYS SHOWGUIDE





Heavy Loading
363kg - 1000kg
800lb - 2204lb

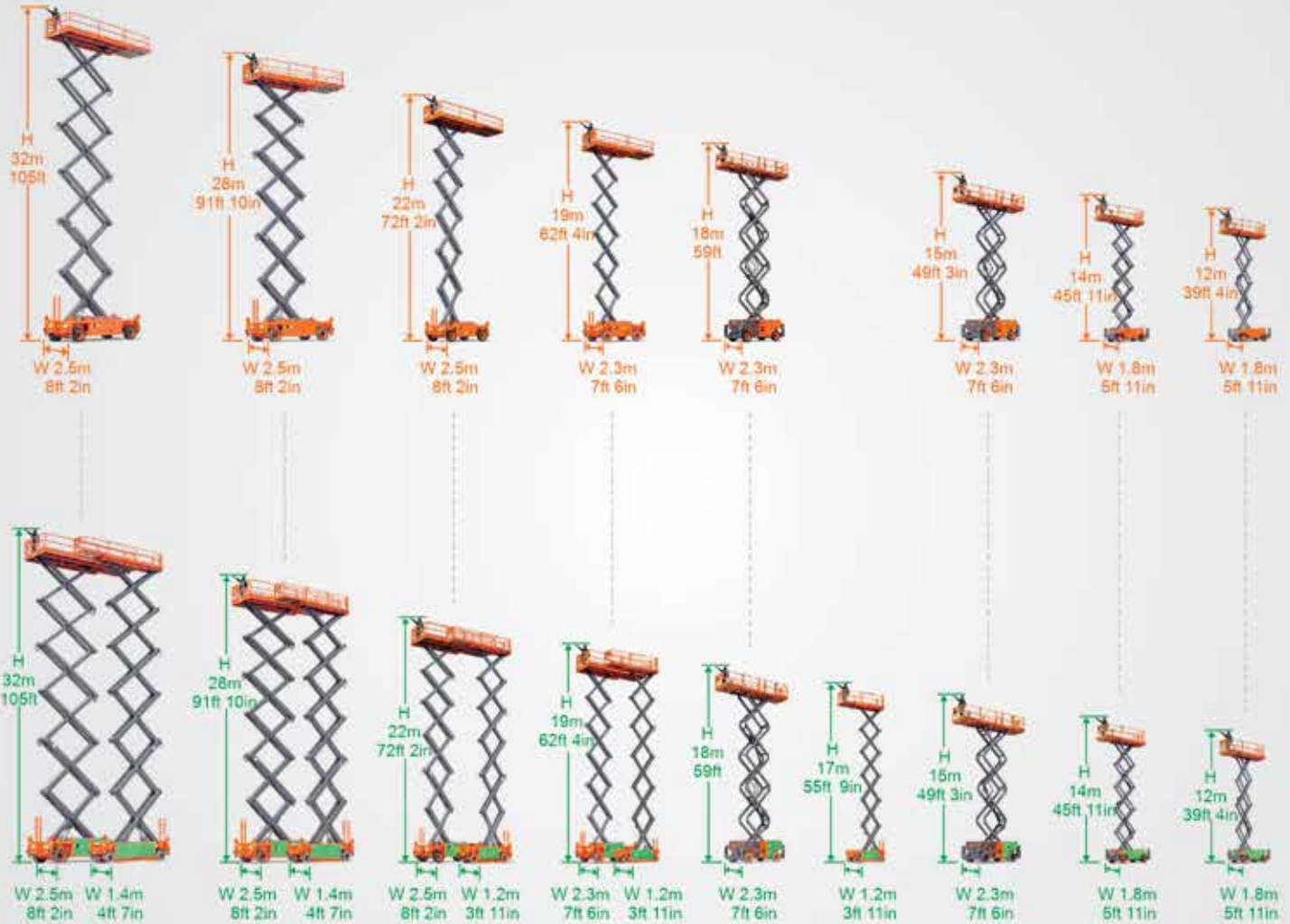

Large Scissor Lifts Series

ZHEJIANG DINGLI MACHINERY CO.,LTD.
 ADD:188 Qihang Road, Leidian Town, Deqing, Zhejiang, P.R.C
 TEL:+86-572-8681688
 Phone:+86-13806523131 Susan Huang
 E-Mail:export@cndingli.com
 Https://en.cndingli.com



Global TOP3

2021 Industry Global Manufacturers Sales Ranking
 *Data source: (Access International)



6



17



25



37



89

CONTENTS

COMMENT 5

NEWS 6

Tadano's new all-electric RT and new truck cranes, Custom-built Gantic tunnel lift, Mec launches 85ft boom, New 700t Liebherr narrow track crawler, Uperio and Geda expand partnership, XCMG 216ft boom and new UK partner, New premises and products for LGMG Europe, Terex to split Crane business, First Liebherr LR 12500-1.0 delivered, Record sale for Euro Auctions, South Korean crane operator licences at risk, Trojan launches new AES battery, IAPA winners, New 135 t/m Effer and financials round-up...

CRAWLER CRANES 17

Chinese construction equipment manufacturers have been producing lattice crawler cranes in significant volumes for many years. However the Ukraine-Russia conflict has opened the door to Chinese exports with the western crane manufacturers affected by sanctions. We take a look at the markets and latest developments.

VEHICLE MOUNTED LIFTS 25

We review the real dangers of working with truck and van mounted platforms near overhead power cables and lines. We also examine a market that is moving ever closer to all-electric powered lifts.

VERTIKAL DAYS SHOW GUIDE 37

The biggest ever Vertical Days returns to the Peterborough Show Ground with a record number exhibitors and products. Our comprehensive guide contains everything you need to know about the show, the exhibitors and the products they plan to showcase.

CONEXPO 2023 REVIEW 89

This year Conexpo was back and bigger than ever and more importantly it had a positive 'vibe' throughout. Here we try to convey the atmosphere with an extended pictorial review.

APEX PREVIEW 97

The Dutch access exhibition APEX returns after an absence of six years following the cancellation of the 2020 event. It also goes back to Maastricht for the first time in 12 years having moved to Amsterdam following the 2011 show. Here we have a flavour of what to expect at the show.

REGULARS

ALLMI FOCUS	101
IPAF FOCUS	103
IN THE NEXT ISSUE	104
CPA FOCUS	105
TRAINING	107
BOOKS & MODELS	109
LETTERS AND OBITUARIES	111
WHAT'S ON	115
ONLINE DIRECTORY	118

ON THE COVER

Don Ahern, owner of Snorkel and Xtreme Manufacturing, with the winning ticket for the raffle of the specially painted Jekko Mini-Picker crane at Conexpo. The event raised more than \$60,000 with all the money going to the Kennedy Krieger Institute which funds research and care treatments for Autism.



IN THE NEXT ISSUE Scheduled for publication in mid June, the next issue of Cranes & Access will include the Vertical Days 2023 show review and features on Low level access, Telehandlers, All Terrain cranes and Recruiting for the lifting industry. If you have any contributions or suggestions to make or are interested in advertising in this issue, please contact our editorial or sales teams.



Promoting the safe and effective use of powered access

GET YOUR PAL CARD ON YOUR PHONE!

WITH IPAF'S NEW APP



ePAL

www.ipaf.org/ePAL

- Free to download
- For all PAL Card holders
- Digital wallet for IPAF licences & qualifications
- Digital logbook
- Show & share your credentials
- Convenient
- Best practice tips & advice

DOWNLOAD NOW

Scan here or search your app store for 'ePAL'





Editorial

Mark Darwin - Editor
Leigh Sparrow

Associate editors

Rüdiger Kopf (Freiburg)
Alexander Ochs (Freiburg)

Feature editors

Will North
Nick Johnson
Saul Chernos

Sales & customer support

Clare Engelke
Pam Penny
Karlheinz Kopp

Production/Administration

Nicole Engesser

Editorial data specialist

Poppy Horne ph@vertikal.net

Subscriptions

Lee Sparrow

Publisher

Leigh Sparrow

Advertising sales

UK-based

Clare Engelke ce@vertikal.net
Tel: +44 (0)7989 970862
Pam Penny pp@vertikal.net
Tel: +44 (0)7917 155657

Germany-based

Karlheinz Kopp khk@vertikal.net
Tel: +49 (0)761 89786615

The Vertikal Press

PO box 6998 Brackley NN13 5WY, UK
Tel: +44(0)8448 155900
Fax: +44(0)1295 768223
email: info@vertikal.net
web: www.vertikal.net

Vertikal Verlag

Sundgauallee 15, D-79114,
Freiburg, Germany
Tel: 0761 8978660 Fax: 0761 8866814
email: info@vertikal.net
web: www.vertikal.net



COMMENT

WALK THE TALK...

There can be few people who have not heard of Jeremy Clarkson. Love him or hate him he has presented some of TV's biggest shows in terms of international viewers, such as Top Gear and Amazon's The Grand Tour. However, he is also famous or infamous in the UK for his newspaper columns which frequently generate complaints and controversy.

His latest TV programme is 'Clarkson's Farm' - a type of documentary series about managing his farm on the edge of the Cotswolds. The series not only has Clarkson up to his usual, hair-brained but entertaining ideas, but also highlights the challenges facing farmers including dealing with bureaucracy.

What has all this got to do with Cranes & Access? Well in the latest series which covers his second year running the farm, farm shop and trying to start a restaurant, he is having to diversify to maintain income at risk from Brexit.

Having read, watched - and enjoyed - his outspoken, un-PC personality for many years I found myself staring at the TV in mild disbelief during one episode in which he was trying to fix a fence, standing between the forks of a telehandler as it held the fence before trying to push in a fencing post. A while later he was working at height from the telehandler's bucket and in another scene was using an indoors only slab scissor lift outside on a slope, trying to work out why it would not operate, seemingly ignorant of the built-in safety systems. At least there was no attempt to edit out the 'bad and the ugly' from the episode.

For many years we have published examples of bad practice and reported on accidents and near

misses - no matter where they are or who is responsible - in order help others avoid the same fate, while stating the facts often distorted by the rumour mill.

We have often been on the receiving end of companies trying to stop publication or supply information for 'witch hunts' to find whistle blowers, as they seek to suppress information on a near miss or incident to keep it out of the public domain or being seen by the safety authorities. It tends to be the same larger companies that also pontificate on how important safety, employee care and inclusion is.

Thankfully the vast majority understand that it is far better to state the facts and share such information for the benefit of everyone. Only this week a large plant in Texas had a serious crane incident. The company's initial reaction was to suppress the whole affair...even though it had suffered a major incident two years ago and has spent serious money assuring the public that it had learnt from the incident and how it now believed in 'motherhood and apple pie'.

The attitude is, in a way, a bi-product of the box ticking mentality we have created, where companies claim to believe in diversity, employee safety and the environment but conveniently forget it all when it comes to implementation. Annual reports now include pages of the stuff, specialist directors sit on boards, asses are well and truly covered but few truly 'walk the talk'.

At least that is one accusation that cannot be levelled at Jeremy Clarkson, he is WYSIWYG - What You See Is - most definitely - What You Get.

Mark Darwin

Comment and feedback is most welcome via post, email, fax or phone stating if we may publish them or not: editor@vertikal.net

TADANO'S ALL ELECTRIC RTS

Tadano unveiled the keenly anticipated 90 tonne GR-1000XL EVolt battery electric Rough Terrain crane at Conexpo. Deliveries begin next year with sales initially restricted to North America. A 25 tonne RT/City crane - the GR-250N Evolt - is being developed for Japan.



The E-Volt superstructure comes from the standard GR-1000XL, but a lithium ion battery pack and electric motor drive the normal hydraulic pumps, while two electric motors - one for each axle - power the drive. Tadano claims the battery is sufficient for a typical nine hour work day and can be recharged in seven hours with the onboard charger, or two hours on a Tesla fast charger. The crane can also be operated while plugged into an AC outlet. A selection switch allows for 30, 50, 75 or 100 Amp inputs. Top speed is 11 mph.

TWO NEW TADANO TRUCK CRANES

Tadano also unveiled two new North American truck cranes - the 110 tonne GT-1200XL-2 with five section, 51 metre pinned boom and 10.3 to 17.9 metre bi-fold swingaway extension - and the 73 tonne GT-800XL-2 with a five section, 47 metre full power boom, which can be equipped with the same 17.9 metre extension. The new cranes use superstructures from the company's GR Series Rough Terrains, mounted on four axle carriers with US running gear and a travel speed of 65 mph. Axle widths and spacings are optimised for permitting, while a trailing boom dolly is available.



GANTIC TUNNEL LIFT

Norwegian powered access specialist Gantic has teamed up with Spanish manufacturer Mecaplus to develop a new boom lift for tunnel maintenance work. The compact Tunnel lift features a two section heavy duty boom, with three metre pedestal mounted platform and a slew ring between pedestal and platform. The maximum working height is nine metres while overall weight is 7,700kg for the standard model or 8,000kg for the bi-energy.

Features include a fully dynamic self-levelling chassis - both side to side and end to end - a rotating platform with 600kg capacity, a high stowed travel speed, self-loading cable drum holder with a trailer hitch to tow an extra drum, extra air filters, a large oil cooler, a built-in electric power pack and oversized Rexroth drive motors. The first machine is going to P2P Rent, with several more already sold. The bi-energy, diesel/lithium model is due later this year.



XCMG PARTNERS WITH BALLYVESEY IN UK

As we go to press XCMG has announced the appointment of Genesis - part of Ballyvesey Holdings - as its UK distributor. Led by Ballyvesey's Mark Kennedy, the new partnership will launch at Vertical Days. We understand a substantial stock of new machines is already on the water.



MEC'S DUAL MODE BOOM

US aerial lift manufacturer Mec has unveiled its largest boom lift to date - the 85ft 'Dual Mode' 85-J - which can be operated as a telescopic or an articulated boom lift. The 85-J uses a heavy duty, over centre single element riser and three section boom, topped by a jib with 135 degrees of articulation. The unrestricted platform capacity is 272kg, with a maximum of 408kg.

A simple switch on the lower controls is used for mode selection. In telescopic mode the riser elevates proportionally with the main boom on a single joystick action, with a maximum outreach of 21 metres. In articulated mode the operator controls the riser independently of the boom elevation function. Maximum up & over height is six metres, with an outreach of up to 16.6 metres. The new 85-J also has two oscillating axles providing up to seven degrees of automatic frame levelling. When the two axles are parallel, the lift can travel while elevated. Four wheel steering is standard.



700 TONNE NARROW TRACK CRAWLER

Liebherr has announced the new 700 tonne LR 1700-1.0W narrow track lattice boom crawler crane to replace the 600 tonne LR 1600/2-W. The LR 1700 has significantly higher capacities and lift heights thanks to the stronger base machine and 3.5 metre wide H-type boom lower main boom sections which increases the lateral rigidity of the entire boom system.

For more information see the Crawler crane feature on page 17



UPERIO AND GEDA EXPAND PARTNERSHIP

German hoist manufacturer Geda and French international tower crane rental company Uperio are expanding their partnership, adding Geda transport platforms to their sales and rental co-operation. The partnership dates back to the introduction of the Geda 2 PK tower crane operator hoist in April 2018.

Uperio added 56 units of Geda's 500 Z/ZP transport platforms to its rental fleet in 2021 for a contract at the Fécamp offshore wind farm project off the coast of Normandy. Given the growing demand for such platforms, Uperio asked for them to be added to their partnership agreement.

NEW PRODUCTS AND PREMISES FOR LGMG

Chinese aerial lift manufacturer LGMG's has moved into its new European headquarters in Dordrecht, the Netherlands, which are 10 times the size of its previous base in Spijkenisse. The new facility needed a five month renovation and is stocked with a substantial inventory of new machines and replacement parts. The operation will also be responsible for sales and support of the company's new telehandler line.

LGMG also launched new 45ft heavy duty, dual capacity diesel powered articulated boom lift the AR14J-H/AR45J-H. The new boom offers a maximum working height of 15.9 metres, a maximum outreach of just over eight metres with the unrestricted platform capacity of 300kg at an up & over height of 7.3 metres. Outreach with the maximum 450kg capacity is 6.5 metres. Four wheel steer, four wheel drive and an oscillating axle are all standard, while the overall weight is 7.4 tonnes. The company says it plans to launch 10 further European aerial lifts and telehandlers during this year.



SNEAK MEGA BOOM PREVIEW

We understand that Chinese manufacturer XCMG will launch a brand new, top end telescopic boom lift early next year. We have a photograph but little to no detail except that it will have a working height in the region of 70 metres, with a five section boom and three section heavy duty articulating telescopic jib.

If our sources are correct, and we have no reason to doubt them, the unit will initially be designed to European standards, with at least the first five or six shipping to Europe in early 2024. With the introduction of such a product, XCMG will join Zoomlion and Snorkel with self-propelled boom lifts over 200ft/60 metres. The 217ft Zoomlion ZT68J has yet to appear in Europe, while Snorkel's 210ft unit, the 2100SJ is only now moving into production. Given the competitive relationship between Zoomlion and XCMG we would expect the new boom - the 224ft XGS70E? - to offer around 30 metres of outreach and will apparently weigh a little less than 30 tonnes.



TRACKZILLA MEGA TELEHANDLER

When visiting any equipment exhibition we try to choose the standout exhibit, usually ending up with several and failing to decide. Not so at Conexpo 2023! Without doubt it was the monster telehandler on the Xtreme/Snorkel stand aptly named Trackzilla, or more formally the Xtreme XR50100-G. Maximum lift height is 30 metres, while the maximum lift capacity is 22.7 tonnes but only to a height of six metres on a retracted boom for a forward reach of 1.4 metres. Capacity at full height is just under seven tonnes, while maximum forward reach is almost 17 metres with a load of 1.8 tonnes.



The behemoth which travels on four massive track units weighs 68 tonnes, has an overall length of 11 metres, an overall width that extends from 3.66 to 5.2 metres and an overall height of 3.35 metres. Features include a tilt/elevate cab, extendable wheelbase and large in cab display. The machine was designed, initially for a speciality contractor that clearly thinks outside of the box.

FIRST LIEBHERR LR 12500-1.0 DELIVERED

Belgian international crane and heavy lifting company Sarens has taken delivery of the first 2,500 tonne Liebherr LR 12500-1.0 crawler crane at a formal ceremony at the Port of Rostock. Sarens plans to use the new crane mostly in the renewable energy sector including offshore wind turbines.



Technical solutions, projects & engineering director Carl Sarens said: "The capacity of the LR 12500-1.0 is enormous. Operations in the renewable energy sector, such as here in Rostock, are a particular focus for the crawler crane. The handling of offshore wind turbines in ports is becoming more and more important and the individual weights of the components are constantly increasing."

Sarens has named the new crane Straffen Hendrik as a tribute to long time employee Hendrick Sanders who has worked for the Belgian company for more than 30 years and is now responsible project planning for large cranes.

The LR 12500-1.0s first job will be to help lift 50 monopiles with overall lengths of up to 90 metres and diameters of nine metres with an overall weight of more than 1,400 tonnes. It will work with an 800 tonne Liebherr LR 1800-1.0 to tandem lift them into the water. The job is expected to take around eight weeks. Including load handling attachments, the two cranes have a combined capacity at the required radius of 1,750 tonnes. The monopiles will be transported to the Baltic Eagle offshore wind farm, which is currently under construction, 30 kilometres north of the island of Rügen in north east Germany.

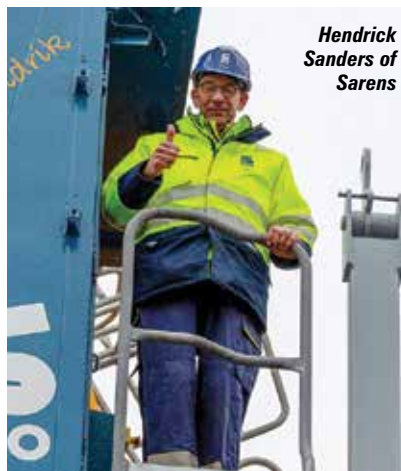

Hendrick Sanders of Sarens

RECORD SALE FOR EURO AUCTIONS

Euro Auctions celebrated its 25th anniversary with a record-breaking sale at its facility in Leeds, UK in late March, in which 6,000 lots fetched around £60 million. Among the items that were sold included a number of relatively young telehandlers.

An example of the prices they fetched can be seen below.

Year	Model and make	specification	Price made
2021	JCB 540-180 Hi Viz	Turbo Powershift, Joystick Controls	£62,000
2020	Manitou MT1840 Easy	Turbo Joystick Controls, Sway	£54,500
2021	Manitou MT1440 Easy	Turbo, Joystick Controls, Sway	£62,000
2021	JCB 540-140 Hi Viz Turbo	Powershift, Sway	£52,000
2020	JCB 533-105 Turbo	Powershift, WLI, Forks	£40,500
2019	JCB 536-95 Turbo	Powershift, WLI, Joystick Controls	£60,000

4,888 bidders registered to take part in the sale with 84 percent bidding on line, however the physical attendance, including floor bidders and the 'camp followers' who like to turn up at each auction for the buzz of a 'big sale' was the largest the company has seen for some time.



JLG ANNOUNCES 'CLEARSKY SMART FLEET'

JLG is to launch a new interactive telematics solution - 'ClearSky Smart Fleet' - later this year. The new development will include a next generation Internet of Things (IoT), with a platform for true two way fleet management and machine interactivity. It will eventually be standard equipment on most JLG machines.

Ara Eckel, director of product management for JLG's connected solutions said: "Telematics today can only do so much. ClearSky Smart Fleet reimagines what's possible, paving the way to a new frontier for connectivity solutions in the industry."



TEREX TO SPLIT CRANE BUSINESS

Terex is to restructure its two Italian crane operations - both of which are based in Northern Italy - into two separate operations, Terex Tower Cranes and Terex Rough Terrain Cranes. Terex also builds the Franna pick & carry cranes in Australia which are not included in the restructuring.

Terex Tower Cranes will be managed by general manager Marco Gentilini and includes flat top, luffing jib, hammerhead and self-erecting tower cranes manufactured at its Fontanafredda facility in north eastern Italy. Nicola Castenetto has been appointed to expand the company's self-erecting tower crane business with responsibility for product development, strategic planning, sales and after-sales functions at a new dedicated production facility.

The Terex Rough Terrain Cranes business will be managed by general manager Giancarlo Montanari and will include the RT and new TRT ranges manufactured at its plant in Crespellano, Northern Italy.

Terex cranes is a part of the Terex Materials Processing division managed by Kieran Hegarty who said: "We are confident that this new structure will focus each business on strengthening their individual and unique brands. They are two completely different sets of products, manufactured in two independent facilities, it makes sense to separate them to provide more focus and clarity."



Nicola Castenetto



Marco Gentilini



Giancarlo Montanari

CRANE OPERATORS ON GO-SLOW?

South Korea is investigating a large number of tower crane operators for "illegally withholding their labour or working at a 'go-slow' pace". The government believes that the operators and their union have deliberately slowed down or stopped work in order to extract additional payments from contractors and their clients.

The Ministry of Employment and Labour launched an investigation into the claims checking 547 construction sites in the country. As a result, 54 crane operators have been found to have illegally suspended work so far, 21 of which are in danger of having their operator licenses suspended for at least three months. A further 33 cases are being processed.

The action is part of the current administration's campaign against what it claims is illegal labour activity and site violence.



NEW PREMISES FOR HAULOTTE SCANDINAVIA

Haulotte Scandinavia has moved into new premises in Landvetter, to the east of Gothenburg, Sweden, close to the airport.

The new purpose-built facility includes a large yard, workshops with overhead crane, warehousing, a dedicated training room and offices. It covers the Nordic region and Baltic states through eight local dealers.



NEW TROJAN AES BATTERY

Trojan Battery has launched a new premium AGM battery - the Trojan AES - aimed at aerial work platform rental fleets and floor sweepers etc... where abuse and poor maintenance are typical.

The company claims that its AES battery has up to twice the cycle life of a standard AGM, a claim it says has been validated with side-by-side testing with the AES achieving 2,500 cycles at repeated 60 percent discharges, compared to 1,200 cycles for a standard AGM. Trojan is backing the new battery with a standard three year warranty. The new battery is essentially a premium VRLA (Valve Regulated Lead Acid) version of its standard AGM (Absorbed Glass Mat).



A great unit for a greater business



+39 071 78 19 090
www.bravi-platforms.com
info@bravi-platforms.com

Vertical
days
STAND 401

MIX
STAND 250

BRAVI
PLATFORMS

3,000T HUISMAN FOR HAVFRAM

Offshore turbine installation company Havfram Wind has ordered a 3,000 tonne leg encircling crane from Dutch international crane manufacturer Huisman for its NG-2000X wind turbine installation vessel being built by CIMC Raffles.

The fully electric crane will be equipped with a 155 metre boom for a lifting height of 180 metres above deck. The crane will be manufactured at Huisman's facility in Zhangzhou, China and prepared for the next generation of tagline systems, with improved capabilities to install the latest wind turbines in more challenging conditions. It has also been optimised for installation of bottom fixed foundations in combination with Huisman's monopile grippers and pre-piling templates.



SKYJACK DOUBLES CAPACITY

Canadian aerial lift and telehandler manufacturer Skyjack has been expanding its global production capability, increasing capacity by 235 percent compared to last year. Production facilities will increase from two in Canada to five, with the new plants in China, Hungary and Mexico. These changes will see the Canadian factories focus on the production of vertical mast lifts and scissors - both slab electric and Rough Terrain - meanwhile telehandler and boom lift production is moving to the new plant in Mexico. January saw the first telehandler - a SJ1056 TH - come off the production line of the company's new plant in Ramos Arizpe, Mexico.

Skyjack president Ken McDougall said: "Prior to Covid we were pushing the boundaries at our Canadian plants and simply had no more space. The pandemic brought new challenges that highlighted the need to revisit supply chain and logistics structures with a view towards more localisation."

Skyjack will also develop the Canadian plants as innovation hubs with an advanced engineering structure co-ordinating design and development activities across the company's three regional business units: Americas, Europe, and Asia Pacific.

Production in Europe has also increased with the expansion of the plant in Oros, Hungary, to 10,500 square metres. Production of the new SJ45 AJ & SJ60 AJ articulated boom lifts began last year, with the plant destined to supply all types of boom and scissor lifts for Europe.



AERIAL LIFTS FOR ISLAM'S HOLIEST SITES

The facilities management division of contracting group Al Majal Al Arabi has started taking delivery of 135 Genie boom and scissor lifts for cleaning and maintenance work on the mosques of Mecca (Makkah al-Mukarramah) and Medina (Al Madinah Al Munawwarah) - the most important and holy sites in Saudi Arabia and Islam.

The new lifts, supplied through Saudi crane, aerial lift and telehandler distributor Medco, include the 60ft S-60 J and 80ft S-80 J lighter weight telescopic boom lifts which will be used for external facade and general offsite maintenance, along with a range of GS E-Drive slab electric scissor lifts for indoor maintenance, and 60ft all-electric Z-60 DC articulated boom lifts for use in general facility management and cleaning tasks.



IAPA WINNERS

The IPAF IAPA awards ceremony was held in Berlin in mid-April. The Lifetime Achievement Award went to Hinowa founder Dante Fracca, who has retired following the company's acquisition by JLG.

The other award winners were as follows:

- Training centre of the year - Dayim Equipment Rentals of Saudi Arabia
- IPAF training instructor of the year - Anna Sarah Costa Morais of Mills Brazil
- Contribution to Safe work at height - Nationwide Platforms UK
- Scissor/vertical mast product of the year - MEC for the MMAE16 mast lift
- Mastclimber product of the year - Maber for the MBC2000 transport platform
- Vehicle mounted lift product of the year - Elliot Equipment for the E150i
- Self-propelled boom lift product of the year - Manitou for the 160 ATJ+e
- The digital development award - Alimak
- The innovative technology prize - Nationwide Platforms for its Harness On device
- Sustainability Award - Genie for its new plant in Mexico
- Diversity and inclusion Award - Vicki Allen of International Platforms - UK
- Access Rental company of the year - Sunbelt Rentals UK
- The IPAF President's Award - Reinhard Willenbrock for services to IPAF in Germany

The new The Founder's Award went to - Macarena Garcia Oliver of Movicarga, Spain
See *IPAF Focus page*

The 2024 Summit and awards ceremony will be held next March in Copenhagen, Denmark.





NEW BIG EFFER

Hiab has launched the new 135 tonne/metre Effer iQ.1400 HP 'super heavy loader crane' with up to a 10 section V10-Force decagonal boom providing a tip height of 25.5 metres, or a 21.48 metre radius with a capacity of 3,700kg.

The maximum capacity is 30 tonnes at 3.2 metres. A seven section jib takes the maximum tip height to almost 40 metres and provides a maximum radius of 33.6 metres, at which it has a capacity of 1,150kg. The jib can be raised by 20 degrees above the horizontal boom, or with the boom elevated to 70 degrees (maximum elevation is 83 degrees) and the jib horizontal, the up & over height is 26 metres with an outreach of 19 metres and a capacity of 1,300kg.



STRONG ATTENDANCE FOR CONEXPO

The Conexpo/ConAg & IFPE shows in Las Vegas last month attracted around 139,000 visitors - a six percent increase on 2020 which was strongly affected by the looming Covid pandemic.

Of the 139,000 visitors 24,000 were classified as International, representing 133 countries. The sprawling layout however meant that some halls or outside areas did not see anything like this number of visitors. Having said that most crane, aerial lift and telehandler exhibitors we spoke with were very pleased with the number and quality of visitors that they saw over the five days. Conexpo 2026 will be back in Las Vegas from March 3rd to the 7th.



KALMAR'S FIRST ELECTRIC HEAVY FORKLIFT

Austrian rail logistics service provider Innofreight Solutions has purchased the first Kalmar high-capacity heavy electric forklift for delivery later this year.

The heavy forklifts can lift up to 33 tonnes to a height of five metres. Power comes from a 670 volt electrical system, with 345KW battery pack, providing around eight hours of work, but opportunity charging of 15 to 30 minutes every two to three hours can keep the battery pack topped up for round the clock work. The company plans to replace all of its 60 diesel machines with electric models.



2-In-1 Crane And Glass Robot



DISCOVER THEM
ONLINE!



MPK06
600 kg Max capacity
Battery Powered

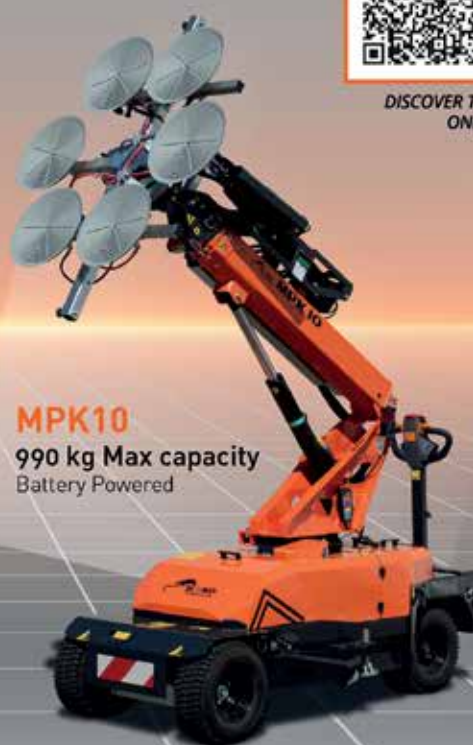

MPK10
990 kg Max capacity
Battery Powered

FINANCIALS ROUND-UP

HIGHER REVENUES AND LOSSES AT AINSCOUGH

UK rental company Ainscough saw revenues for the year to September 2022 improve eight percent to £96.5 million, but pre-tax losses jumped from £1.1 million to £3.18 million, mostly due to a £2 million jump in interest costs for short term loans that have since been refinanced and higher operating costs.



TADANO PICK UP CONTINUES

Tadano revenues for the nine months to the end of December increased 12.3% to ¥192.9 billion (\$1.47 billion). Pre-tax profits however almost halved to ¥7.6 billion (\$57.6 million) due to an exceptional gain last year of ¥10.2 billion (\$77.1 million), without this pre-tax profits almost doubled.



RED INK AT HAULOTTE

Haulotte reported a loss for 2022 in spite of 18% revenue growth. Total revenues were €608.25 million however pre-tax profits plunged from €16.1 million in 2021 to a loss of €9.58 million, driven by €47.8 million of cost increases relating to components, energy and transport as well as exchange rate losses - mostly against the dollar.



OSHKOSH INVESTS IN LIDAR

JLG parent Oshkosh has made a strategic investment in Australian start up business Baraja which develops advanced LiDAR solutions (Light Detection And Ranging or Laser Imaging, Detection, and Ranging) which determines distances by targeting an object with a laser and measuring the time for the reflected light takes to return to the receiver. It hopes the technology will enhance and differentiate its products in terms of safety and autonomous operation.

€1 BILLION YEAR FOR KILOUTOU

French international rental company Kiloutou achieved record revenues in 2022 of €1.02 billion, an increase of 28.4% on the year of which organic growth was 6.6%. The company does not disclose its full accounts.



VP TRADING STATEMENT

UK rental group Vp - owner of UK Forks, MEP and Brandon Hire - says it made good progress in the six months since November and expects to report full year results in line with expectations.



BIGGE ACQUIRES EMPIRE

Bigge Crane and Rigging has confirmed the acquisition of a majority stake in Syracuse, New York sales and service company Empire Crane Company from owners Luke and Paul Lonergan.



AER ACQUIRES HUDSON LIFTING

UK rental group AER Rents - owned by Ireland's O'Flaherty Holdings - has acquired lifting gear sales and rental company Hudson Lifting of East Tilbury, Essex. Hudson had net assets of £2.35 million in late 2021, with a tangible net worth of more than £830,000, as well as a very positive working capital position and strong balance sheet.



SARENS FAMILY REGAINS 100%

The Sarens family has regained 100% of the equity in its heavy lift and transport business by purchasing the 22% stake in the business owned by Belgian entrepreneur Luc Tack through his Begoos water treatment division. The Begoos seat on the Sarens board has also been removed as part of the deal. No details of the transaction have been disclosed.

SWEDISH ACQUISITION FOR LOXAM

Loxam's Nordic operation - Ramirent - has acquired Swedish rental company Jiab Hyrcenter and subsidiaries from owners Jiab Fastighets, Kex Invest and Ave Capital Invest.



ANOTHER ACQUISITION FOR BAY CRANE

New York based Bay Crane has acquired fellow New York crane rental company Cranes, Inc which runs a fleet of mainly Liebherr cranes including ATs, lattice crawlers, RTs and telescopic crawlers with maximum capacities of 500 tonnes.



FELBERMAYR TO ACQUIRE DORN

Austrian crane, aerial lift and telehandler rental company Felbermayr is to acquire aerial lifts sales and rental company Dorn Lift which distributes Hinowa, Multitel, Haulotte and Ommé products in Austria and Germany. The Dorn Lift sales operation will continue to operate as a stand alone business, while its rental operation will be incorporated into the group.

RECORD REVENUES FOR LIEBHERR

Liebherr achieved revenues of €12.58 billion in 2022, an increase of 8% and a new record. Pre-tax profits however slumped 70% from €812 million to €246 million, due to higher costs. Mobile and crawler crane sales improved 4.6 percent to just over € billion, driven by higher sales in North America, Africa and the Middle East.



ANOTHER ACQUISITION FOR KILOUTOU

French international rental group Kiloutou has acquired the French regional rental company Bernard Location from its owner and manager Bernard Laveau. The company is located in Montréal-la-Cluse between Lyon and Geneva.



ASSTEAD GROWTH CONTINUES

Ashtead has posted revenues of \$7.2 billion for the nine months to the end of January, up 25% on last year, driven largely by North America. Pre-tax profits for the period jumped 33 percent to \$1.69 billion.



FGS ACQUIRES CLEMENTS

UK group Heathcote Holdings/FGS Plant Hire has acquired Coventry based rental company Clements Plant & Access Hire from its owner Jim Longstaff who has left the business with Stuart Willy taking over as chief executive.



PROFIT DIP FOR MANITOU

Manitou's 2022 sales jumped 26% to €2.36 billion however pre-tax profits slipped 31 percent to €79.6 million due to higher costs that could not be passed on through price increases due to the large order book/back log. The company has kicked off the year with a 48% increase in first quarter sales.



RECORD FIRST QUARTER FOR HAULOTTE

Haulotte has reported a 45% jump in first quarter revenues to €196.3, driven by a 50% increase in new equipment sales.

MORRIS LESLIE ACQUIRES HARBOROUGH

UK rental company Morris Leslie Plant Hire has acquired the assets of Harborough Hire Centre including its location in Market Harborough, from John and Deborah Bates.



HAULOTTE UNVEILS HYDROGEN SCISSOR

Haulotte exhibited a prototype hydrogen fuel cell system that it is developing in partnership with Bouygues Energies & Services at the Hyvolution exhibition and Summit in Paris earlier this year.

The unit on display was an all-electric Pulseo HS 18 Pro full size electric Rough Terrain scissor lift, equipped with a removable and interchangeable Range Extender generator operating with a Bouygues Hyvision hydrogen fuel cell system.



ONE YEAR ON FOR UKRAINE AID ALLIANCE

In the 12 months since the formation of the UK based - but international - Plant and Hire Aid Alliance the all volunteer project has handed over more than £2 million worth of aid directly to individuals in Ukraine.



Much of it was delivered in two large convoys of vehicles driven by staff of the volunteer companies. Aid provided so far includes: 1,600 mattresses, 3,000 blankets, 300 Antler suitcases, 60 tonnes of food, 50 tonnes of medical supplies, 1,500 crates of mixed aid, 30,000 Christmas presents and 135 generators.

A further convoy taking humanitarian aid via Kosice in East Slovakia is planned for October the 15th and 16th. Founder Jeremy Fish said: "The route and channel for distributing aid is now well and truly 'tried and tested' and very straightforward. If anyone would like to join the convoy, please let me know as we'll start to get a list together in the next few weeks. Also,

if any Alliance members are interested in organising events, fundraisers or are willing to lobby their contacts for donations then please get in touch. Every penny we raise goes to Ukraine, we have no overheads and everything we do is on a voluntary basis."



You too can join the alliance and join the cause by volunteering or donating directly to the generator appeal - simply go to the Alliance's Just Giving page www.justgiving.com/fundraising/ukraine-gensets, every single penny is used to the purchase generators, with the delivery through Ukraine's Rotary Club.



Come visit us at Apex



Discover the latest in lift technology from Holland Lift at the Apex tradeshow. Our fully certified scissor lifts comply with the most stringent regulations for indoor and outdoor use, including ANSI and CSA, and a working height up to 34 metres. We are committed to innovation, safety and quality.

Visit our website for more information. Our team is looking forward to welcoming you at our booth at Apex 2023!

Holland Lift International bv
t: +31 (0) 229 285 555
e: info@hollandlift.com
www.hollandlift.com

BOOTH: 350

A09JE / A13JE-Li / A14JE / AR20JE

ELECTRIC ARTICULATING BOOM LIFT



Booth Number:
420
6-8 JUNE / 2023



Booth Number:
200/300
10-11 MAY / 2023

WORKING HEIGHT RANGING FROM 11 TO 21.58 METERS

MODELS	A09JE	A13JE-LI	A14JE	AR20JE
WORKING HEIGHT MAX.	11m	15m	15.8m	21.58m
PLATFORM CAPACITY	230kg	200kg	230kg	UNRESTRICTED 260kg RESTRICTED 350kg

GREEN
TECH

LOW
NOISE

ZERO
EMISSION

FASTER
CHARGING



LINGONG HEAVY MACHINERY CO., LTD.

Address: No. 2676, Kejia Road, Jinan, Shandong, China
Email: sales@lmg.com.cn Tel: +86 531 6787 9283

LGMG Europe B.V.

Address: Donker Duyvisweg 301, 3316 BL Dordrecht, The Netherlands
Email: sales@lmg.europa.com Tel: +31 850 642 777

www.lmglifts.com



RELIABILITY IN ACTION

NEWS HIGHLIGHTS

- Germany's **Kranverleih Wilhelm** has taken a **Grove GMK5150XL AT**
- Spain's **Transgruma** has taken three 20m **Multitel HX200 EX**
- UK's **Southern Cranes & Access** has taken five **Liebherr ATs** equipped with refinery kits
- Germany's **Krösche-Kran Service** has taken a 50t **Tadano HK 4.050-1** truck crane
- The UK's **CPA** has appointed **Katie Kelleher** as technical and development officer
- Italy's **Pergamo Sollevamenti** has taken a new 700t **Liebherr LTM 1650-8.1**
- Paramount Platforms** has taken nine **Hinowa** spider lifts including the first 40m **LL40.18** in the UK
- Turkish crane company **Kuşgöz İzmir Vinç Kiralama** has taken an 800t **Liebherr LTM 1750-9.1**
- Self-propelled scissor lift pioneer and access industry icon **John W. Parker** has died
- Spain's **Grupo Roxu** has taken its first **Zoomlion** platforms
- Almac/AlmaCrawler** has appointed **Karim Sinno** as sales manager, material handling
- Germany's **Schuch Heavylift** has taken eight new **Grove All Terrain** cranes
- Sweden's **Aspen Maskinuthyrning** has taken 18 **Niftylift** all-electric boom lifts
- US **Circle 8 Crane Service** has appointed **Arnold Mabee** as chief executive
- Dutch rental company **Hermis** has taken the first 70t **Tadano HK 4.070-1** in the Netherlands
- UK's **Morris Leslie Plant Hire** has acquired **Harborough Hire Centre**
- Germany's **Härzschel Kranverleih** has taken a 50t **Tadano HK 4.050-1** truck crane
- German access veteran **Thomas Hässler** has retired from **Hässler-Lift**
- France's **Freche Location** has changed its name to **FLS** and taken a new **Multitel MJ525** truck mount
- Germany's **Sahalift** has opened purpose-built premises for southern Germany
- Link-Belt's** marketing manager **Bruce Kabalen**, has retired - **Rebecca Vaughn** takes over
- King Lifting** in the UK has taken seven new **Liebherr All Terrain** cranes
- Eurasian Machinery**, the **Grove** distributor for Kazakhstan, now covers Uzbekistan, Kyrgyzstan, Tajikistan and Turkmenistan
- Polish company **Błażej & Roman Ustugi Dźwigiem** has taken a 700t **Liebherr LTM 1650-8.1**
- Magni Telehandlers** has appointed **Patrick Degen** as business unit director for aerial work platforms
- Dublin's **Doyle Shipping** group has taken a **Liebherr** hybrid RTG crane
- Italy's **Boiano Service** has taken a 450t **Tadano AC 7.450-1 All Terrain**



Katie Kelleher



John W. Parker



Karim Sinno



Arnold Mabee

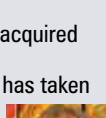

Thomas Hässler



Bruce Kabalen



Rebecca Vaughn



Patrick Degen

- UK company **Total Lifting Services** has taken a new **Böcker AK 52** truck crane
- Genie** has appointed **Markus Bandura** as dealer manager Austria, Switzerland and Germany
- Palfinger UK** has acquired parts, service and crane mounting company **Truck Hydraulic Service**
- Haulotte Scandinavia** has moved into new premises
- US company **TNT Crane & Rigging** has appointed a **Mark Irion** as chief executive
- German roofer **Alfred Heupel** has taken a **Tadano AC 3.055-1**
- Manitow UK** distributor **T H White's** expanded area now includes the West Midlands
- Palazzani** has appointed **Ets. Mazeau** as its distributor for France
- Manitow** has teamed up with **Siemens Digital Industries Software** to manage its products design and lifecycles
- Bob Hughes**, MD of UK distributor **CLM** has retired
- Crane and access industry veteran **David Hall** of **Skyjack** has retired
- Tadano America** has appointed **Hutton Strader** as its new product manager for ATs in the Americas
- Cadman Cranes** has taken the UK's first 80t **Tadano AC 4.080-1**
- Sunbelt Rentals** has promoted **Monica Ziegler** to the new role of chief people officer.
- Germany's **System Lift** has appointed **Sinoboom** as an official supplier
- Canada's **A.W. Leil Cranes & Equipment** has taken the first **Grove GMK6400-1** in Canada
- UK's **Ellis Crane Hire** has added a third 40 tonne **Liebherr LTM 1040-2.1**
- Maxim Crane Works** has appointed **Rebecca Bolchalk** as chief Human Resources officer, **David Reed** as VP of IT, and **Nick Oldfield** as VP digital and marketing
- UK's **Ballyvesey Holdings** has taken six 65ft **LGMG** lithium boom lifts
- A crane operator was injured when he swerved to avoid a **Kangaroo** in NSW, **Australia**
- UK's **Tracked Carriers** has appointed **Ben Dobson** as business development manager
- UK rental company **DM Cranes** has taken a second **Spierings SK1265-AT6 eLift**
- Altrad** announced the departure of most of the **Sparrows Group** leadership team
- Germany's **Schmidbauer** has taken a **Tadano GTC-2000** telescopic crawler crane
- LGMG** has a supply agreement with Italian electronics supplier **COBO**
- Hong Kong's **Gammon Construction** has taken the first **Liebherr** battery powered crawler crane in Asia
- Riwal** has promoted **Johan van Klinken** to chief commercial officer of **Riwal Holding**
- Speedy** has opened a second 'sustainable service centre' in **Leeds, UK**



Markus Bandura



Mark Irion



Hutton Strader



Monica Ziegler



Rebecca Bolchalk



David Reed



Nick Oldfield



Departing Sparrow executives



Johan van Klinken

- Platformsales.eu** has taken over the distribution of **CTE** truck mounts for the Netherlands
- Magni Telehandlers** has appointed **Kirby-Smith** as dealer for Oklahoma and West Texas.
- German access and telehandler sales manager **Hans Georg Krause** has died
- Bigge Crane and Rigging** is adding a **Liebherr LRT 1130-2.1 RT** to its fleet
- Spain's **Grúas Aguilar** has taken 11 **Liebherr** cranes
- Sinoboom** celebrated its 15th birthday at **Conexpo** in Las Vegas
- Ruthmann** has appointed **Christian Roß** as head of international sales
- Chinese company **Maclift** has purchased four **Easy Lift** spider lifts
- Leguan Lifts** as appointed **Avant Tecno Italia** as its distributor
- Belgium's **Wim Verhuur** has taken 70 **Magni** branded scissors
- Nationwide Tower Cranes** has taken the UK's first **FB Gru's** new **GA301** self-erecting tower crane
- UK's **HSS Hire** has purchased 100, 19ft **Sinoboom 1932ME** scissor lifts
- UK's **Eastern Crane Hire** has taken a second **Böcker AK 46/6000** truck crane
- Austria's **W. Reitingner** has taken three new **Haulotte** aerial lifts
- Haulotte** has appointed **Sara Fakhraei** as marketing director for the Americas
- CTE** has appointed **Hydroequip** for its truck mounted platforms in the **UAE**
- Dutch manufacturer **Spierings** is to stop producing conventional diesel cranes
- Levels Above** has taken the first 14ft **LGMG SS0507E** scissor lifts in UK/Ireland
- An **Australian** crane company has been fined \$400,000 following a fatal incident in 2018 caused by a missing **split pin**
- Germany's **MSG Krandienst** has taken 13 cranes from **Liebherr** including an 800t **LTM 1750-9.1**
- Dubai's **Al Faris** has taken a **Tadano GR-800EX RT** crane
- MEC** has appointed **Paul Waller** as vice president business development
- Rental Equipment Investment Corp** has acquired **Black Mountain Rentals** of Pinewood, Wyoming
- JCB** has appointed **Keith John** as access sales manager for Europe
- Germany's **Wiesbauer** has taken a **Liebherr LR 1700-1.0**
- Tadano** has promoted **Dean Barley** to CEO **Tadano America**
- Socage** has appointed **Stefan Weber** as export sales manager
- Snorkel** has appointed **Craig Revell** as business development director Middle East & India
- Italian manufacturer **Axolift** has appointed **Pop Up Products** as its UK/Ireland distributor
- Dutch dealer **Kraan-en Truck Service** will distribute **Isoli** in place of **CTE**
- Scotland's **Global Crane Services** has taken a 220t **Liebherr LTR 1220**
- Kranlyft** has appointed **Klaas** as **Maeda** sales & service partner for Germany
- Riwal** has agreed a partnership with training company **Biom Opleidingen**
- Italy's **Issa Autogrù** has taken 25 new **Multitel Pagliero** platforms
- Indonesia's **Superkrane** has taken a **Grove GRT8120 RT** crane - the first in Asia
- Bob Francis**, the founder of **Bob Francis Crane Hire** in North Wales, has died



Hans Georg Krause



Christian Roß



Sara Fakhraei



Paul Waller



Keith John



Stefan Weber



Bob Francis

See www.Vertikal.net news archive for full versions of all these stories



FIVE-AXLE SUPREMACY.

The longest boom on five axles.

With the longest boom and high capacities combined with a small footprint and excellent maneuverability, the new GMK5250XL-1 pushes past boundaries.

- Longest boom, highest-rated capacity and best load charts in its class
- 78,5 m, eight section TWIN-LOCK® boom with MEGAFORM® design
- Transmission with water retarder or optional VIAB turbo retarder clutch for premium maneuverability
- Best operator comfort and convenience
- Quickest set-up times
- Crane Control System (CCS) with graphic display and jog dial

■ Put power and performance to work for you.

To learn more, get in touch with your local Grove contact today, or go to www.manitowoc.com

GMK5250XL-1

- Capacity: 250 t
- Main boom: 78,5 m
- Maximum jib: 33,8 m
- Maximum tip height: 109 m
- Engine: Mercedes Benz 390 kW Euromot 5/ Tier 4 final



CRAWLERS ON TRACK

The Ukraine-Russia conflict has had an impact on business mostly for the worse, at least in the short term. However, as crisis goes, there are those who benefit, and this is certainly the case for Chinese crawler crane sales. With western crane manufacturers affected by sanctions the door has opened more widely for the Chinese companies which are not subject to the sanctions.

Chinese construction equipment manufacturers have been producing lattice crawler cranes for many years, and in significant volumes, mostly for its sizeable domestic market, which some have estimated to take as many as 3,000 units in some years, roughly the same as for the rest of the world. The leading companies such as Sany, XCMG and Zoomlion have also been exporting, and have been particularly successful in markets where the Chinese government has funded major infrastructure projects.

While they have struggled to make a major impact on Western markets, Chinese manufacturers - since the election of its leader Xi Jinping in 2013 and the slowing down of its economy a few years ago - have been looking to export more and more of its products and have been refining and improving their products. This is particularly true with cranes up to around 250 tonnes where they mostly compete with Japanese manufacturers - the toughest possible in terms of quality and reliability - and they have been learning and adapting.

CHINESE SECOND WAVE

The Chinese crawler crane manufacturers first made forays into overseas markets at the end of the 1990s and early 2000s, but the quality and design were lacking. In what you might call a second wave, the products have improved considerably. Chinese built cranes are now seen on the largest infrastructure projects around the world, for example at the NEOM project in Saudi Arabia. The project - an initiative of Saudi Arabia's ruler crown prince Mohammed bin Salman - is a mega project covering 26,500 square kilometers, with a new city, resorts and other developments including a floating industrial complex and global trade hub, all powered exclusively by renewable energy sources. The developers hope that the majority of the city will be complete by 2039. However, even though the development is still at ground level cranes are already on site ahead of time ready to work - possibly thanks to availability, not a luxury afforded by Western manufacturers whose delivery times can be from six months to two years depending on the size of the crane.

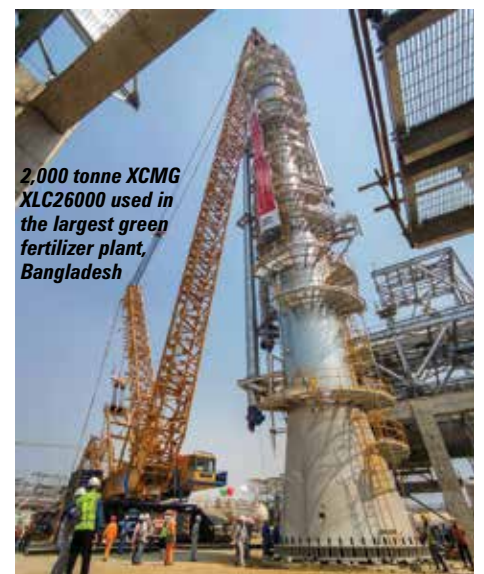

2,000 tonne XCMG XLC26000 used in the largest green fertilizer plant, Bangladesh



Sany's 4,500 tonne SCC45000A - claimed to be the largest crawler crane in the world

THE UK LAUNCH OF THE 17M FULL ELECTRIC TELEHANDLER



SEE THE 6.26 AND 17.45
ON OUR STAND AT

**Vertical
days**
10-11 MAY 2023



FOR MORE INFORMATION ON THE FULL RANGE OF GGR GROUP PRODUCTS, PLEASE VISIT US AT: WWW.GGRGROUP.COM
OR CONTACT US ON +44 (0)161 683 2580 (NORTH), +44 (0)1844 202 071 (SOUTH), +44 (0)1698 824 444 (SCOTLAND).

**GGR
GROUP**



MAJOR US MARKET

Outside of China, the largest crawler crane market is North America which typically takes around 400 units or about 13 percent of the market. The US market is dominated by Liebherr, Link-Belt, Kobelco and Tadano - probably in that order in terms of value - with Link-Belt currently doing particularly well with its small to mid-range cranes and Tadano possibly suffering from the Demag acquisition transition effect.

Liebherr claims that its 300 tonne LR 1300 is the most popular lattice crawler crane in its class, selling between 40 and 60 units per year, with between 80 and 90 percent sold into the States. Liebherr crawlers are built at two facilities - Nenzing in Austria which produces lattice crawlers up to 400 tonnes and Ehingen in Germany for the larger capacity models - 500 tonnes and upwards topped by the 3,000 tonne LR 13000 and the soon to be launched 2,500 tonne LR 12500-1.0.

Liebherr's recently introduced 400 tonne LR 1400 SX is the largest crane produced in Nenzing and is sold as a typical lift crane for tilt up construction in the US. In Europe All Terrains rule the roost, although the Netherlands, with soft ground requiring major foundation works for most projects, is also a major market for small to mid-range crawler cranes.

While the 600 tonne plus cranes used on the wind and major infrastructure projects are the headline grabbers, the bread and butter sector is around the 100 tonne capacity range. In China a good proportion of its crawler cranes are even smaller at up to 50 tonnes as was the case in Europe in the 1960s and 1970s.

HIGH CAPACITY CRAWLERS

In recent years crawler cranes have peaked at around 4,500 tonnes, at least for series production models. This is due to the big heavy lift contractors when working on large projects

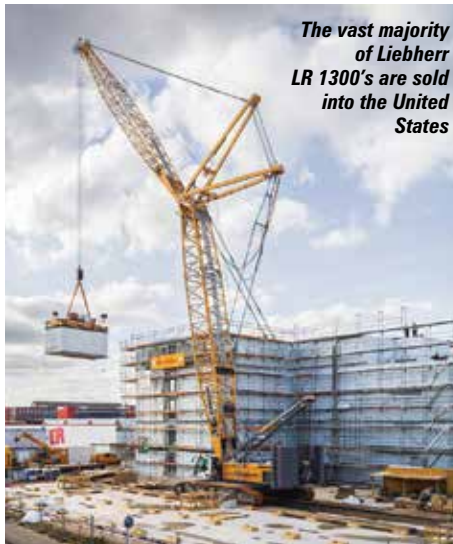

The vast majority of Liebherr LR 1300's are sold into the United States

preferring to build their own modular lifting machines or jacking systems and gantries to lift very large modules or bridge sections. Easy mobilisation is not a problem as they would remain on site for several years.

The world's largest 'production' crawler cranes are now manufactured by Chinese companies XCMG and Sany. XCMG has its 4,000 tonne XCMG 88000. A few years ago, a unit owned by Sinopec Engineering carried out several big lifts - the first outside of China - lifting and placing three washing tower vessels - the heaviest being 1,926 tonnes - at an ethylene oxide/ethylene glycol III plant in Saudi Arabia. The XCMG 88000 was rigged with 102 metres of dual boom, topped by a dual 27 metre jib with a 1,750 Terex Demag CC-8800 crawler crane used to tail in the vessel.

The crane - a joint development between Sinopec and XCMG - first went into service in 2013 completing about 150 heavy lifts on projects all over China. The crane's heaviest lift was a test load of 4,500 tonnes. Although telescopic crawlers are not covered in this feature, early last year XCMG announced the 2,000 tonne XCC2000 'Windflex 4' telescopic crawler crane designed for wind turbine installation. On its first job the XCC2000 lifted a 132 tonne nacelle to a hub height of 145 metres. The crane used the fully extended main boom plus around 60 metres of cable supported lattice extension for a maximum tip height of around 165 metres. According to the company the lift took just 20 minutes and that once the blade assembly was installed the crane



An XCMG 88000 lifting and placing three washing tower vessels - the heaviest being 1,926 tonnes - at an ethylene oxide/ethylene glycol III plant in Saudi Arabia



XCMG's XLC26000 in Bangladesh

was ready to travel to the next turbine foundation within three hours.

More recently Sany has announced what it claims is the largest crawler crane in the world - the 4,500 tonne SCC45000A. In twin boom configuration the crane has a maximum load moment of 98,000 tonne/metres and features a 126.5 metre main boom plus a 15.5 to 48.5 metre fixed jib, while a 30.5 to 108.5 luffing jib can be added for a maximum system length of 216.5 metres. It has a 62 metre twin Superlift back mast/derrick boom which provides a ballast radius of 28 to 37 metres for its tracked counterweight system.

FIRST LR 1400 SX IN OPERATION

One of the main reasons Atlanta-based Full Tilt Crane Services added a 400 tonne Liebherr LR 1400 SX to its fleet was to lift larger and heavier panels. "The crane is used to lift concrete tilt-up panels on a site in Atlanta, which are being manufactured on site by our parent company Martin Concrete Construction," said managing director Jason Richardson.

The largest tilt-up panel has a height of about 34 metres - much larger than would be available in the precast market. Producing on-site is more flexible than precast and the LR 1400 SX plays a significant role thanks to its easy set-up and transportation despite its size. With the base transport weight of 46 tonnes, it can be easily moved between the jobsites a positive advantage as the company frequently moves from job to job, often completing projects within one to two weeks. The company says that it can fully self-assemble the LR 1400 SX in less than 12 hours with platform and guard rails simply folding down for transport rather than being removed.



Full Tilt Crane Services added a 400 tonne Liebherr LR 1400 SX to its fleet to lift larger and heavier panels

CRAWLER CRANES

The crane can also be set up with a single boom with a maximum capacity of 2,000 tonnes. In this configuration it offers a main boom length of 108.5 metres or 102 metres with an 18.5 fixed jib. A 108.5 metre luffing jib can also be installed on a 96 metre main boom, with a 53 metre derrick boom and suspended counterweight radius of 27.5 to 33.5 metres.

The SCC45000A follows on from the 3,600 tonne SCC86000TM launched in 2011 and the 4,000 tonne SCC40000A introduced last year. The first unit has been taken by Shandong based heavy lifting and haulage specialist WH Lifting.

2,500 TONNE LIEBHERR

Last year Liebherr unveiled an all-new 2,500 tonne crawler crane - the LR 12500-1.0 - which it said introduces new design concepts that will eventually migrate through the rest of its range. The crane's all-new superstructure frame and main boom design provide a wide main boom cross section, which the company has dubbed the "HighPerformanceBoom," offering similar stability to its PowerBoom while keeping individual elements compact enough for economical transport and shipping.

The "HighPerformanceBoom" features a front section with a transport width of four metres while the rear section is 3.5 metres wide. The new boom sections are 10 metres in length and incorporate a new mechanism to reduce their overall dimensions for transport. A separate device stabilises the lattice section during the assembly on site. It has a maximum length of 110 metres and can be extended to 155 metres using sections from the luffing jib. Maximum hook height is around 200 metres with 100 metres of main boom and a 108 metre luffing jib.

The crane's derrick boom suspended ballast pallet comes from the 3,000 tonne LR 13000 as do most of the counterweight slabs. It also adopts the LR 13000's B0 version allowing it to operate without derrick ballast. When used the suspended ballast is infinitely adjusted by the crane management system. The LR 12500 will feature twin Liebherr six cylinder diesels with a redundant design in order to ensure availability in the case of a breakdown or servicing.

The new model fills the gap between the 1,350 tonne LR 11350 and 3,000 tonne LR 13000 and is aimed at meeting the growing demand for large crawler cranes from the renewables, petrochemical and port handling sectors to lift increasingly heavy offshore wind components. The lead customer for the new crane is Sarens.



First picture of Liebherr's all-new 2,500 tonne crawler crane - the LR 12500-1.0



Manitowoc has upgraded and updated its 250 tonne 999 into the MLC250

MANITOWOC UPDATES

Manitowoc has upgraded and updated its 250 tonne 999 into the MLC250 lattice crawler crane, using common componentry and designs to other models in its range. It has also launched a new Wide Boom Plus kit for its 350 tonne MLC300. While the MLC250 includes significant updates and changes it retains many of the characteristics of the Maniowoc 999 while providing more operator comfort and being easier and more efficient to repair and maintain.

The key specifications and load charts remain largely unchanged, with the same boom sections and 88.4 metre maximum boom length, while jib choices include a 24.4 metre fixed jib or 73.2 metre luffing jib. One significant difference is a switch to open-loop hydraulics rather than the 999's closed-loop system. Now, every main function aside from slew is powered by the same two main pumps, improving performance. Power comes from a more efficient Tier 4F/EU Stage V Cummins.

Taking inspiration from the MLC100 and MLC150, the new model features fabricated steel component enclosures with swing open doors, rather than the fiberglass gullwing doors of its predecessor and the track drive motor is relocated from the carbody to a direct drive on the track frame for improved performance. The new operator's cab is wider, tilts up to 20 degrees and features the easier to use and more modern Maniowoc Crane Control System (CCS) with a full colour graphic display and dual axis electronic joysticks. An optional 'Vision Cab', is also available, similar to that offered on MLC300 and MLC650 models.



The new cab on the MLC250 tilts by up to 20 degrees

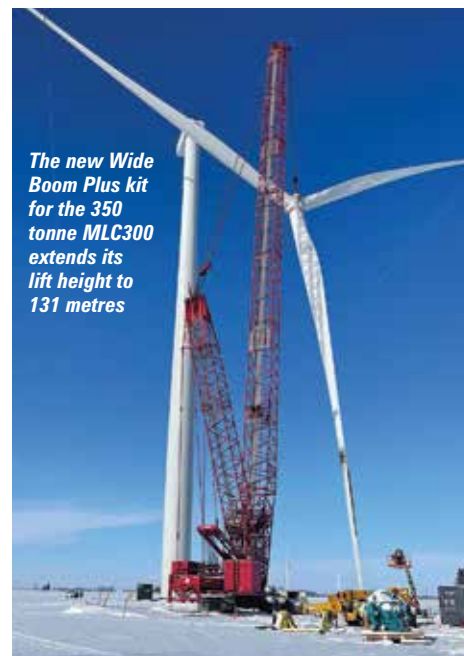

The new Wide Boom Plus kit for the 350 tonne MLC300 extends its lift height to 131 metres

WIDE BOOM PLUS KIT

The new Wide Boom Plus kit for the 350 tonne MLC300 extends its lift height to 131 metres when used with the VPC-MAX superlift system and extended upper boom points. The kit is made up of several 3.5 metre wide boom inserts that are installed to the base section, topped by a transition section to which the regular boom is connected. Aimed at wind turbine installation it adds almost 30 metres to the standard main boom.

Manitowoc product manager Brennan Seelinger said: "Wind turbine work above 90 metres currently requires a 400 tonne or larger crane which can result in higher costs for operation and transportation. Our new boom inserts will open up more jobs for crawler crane owners and increase utilisation of our MLC300 with added flexibility."

BIGGER TADANO?

Tadano's integration of the Demag products continues although most of the new product launches so far have been All Terrains. This may be changing with rumours that the company may introduce a new crane, possibly larger than the 1,600 tonne CC 88.1600-1 later this year or early 2024. Watch this space!



Tadano may be planning a big crawler crane launch later this year?



**The right crane
for the job**

Boom extensions,
luffing jib, Boom Booster Kit,
and other modules can
be added as needed.

Easy handling

Intelligent counterweight system,
slabs interchangeable for all CC cranes.

IC-1 Remote

IC-1 Remote gives you access to
advanced real-time diagnostics
and much more.

Easy rigging

Quick-connection system allows superstructure
to be installed or removed in less than 15 minutes.

Take a closer look at Tadano.

Discover how our DNA can fuel your passion for lifting.

When the job demands something unusually big, powerful and reliable, a Tadano lattice boom crawler crane is the perfect solution. They have excellent capacities up to 3,200 t and maintain outstanding maneuverability under heavy load.

Despite their size, Tadano lattice boom crawler cranes are easy to transport and quickly rigged on the job site. Innovative solutions provide you with the right crane for every application.

Learn more about Tadano lattice boom crawler cranes at tadanoworld.com



CRAWLER CRANES



Link-Belt launched a new, fifth generation 110 ton/100 tonne 218|V lattice crawler crane at Conexpo

NEW LINK-BELT 218|V

Link-Belt launched a new, fifth generation 110 ton/100 tonne 218|V lattice crawler crane at Conexpo. The crane has been the workhorse of general contractors and engineering firms in the USA for more than 35 years since the original HYLAB introduction.

New features include a 12 inch touchscreen LMI operating system which offers better visibility, ergonomic foot pedals are closer to the cab floor offering better unobstructed views of ground level. The new display features an operator interface with new counterweight sensing for live readout of stacked counterweights, live ground bearing, swing angle indicator, list and trim indicator, engine RPM monitoring and improved diagnostics. The crane operator is assisted by on-board high-resolution winch view, back-up and non-cab side swing view cameras with night vision. Power is supplied by a Cummins Stage V engine which can run on hydrotreated vegetable oil (HVO) diesel.

The 218|V self-assembles with 30,844kg of upper counterweight and 13,698kg of lower car body counterweight. The counterweight removal system is common to Link-Belt's telescopic crawler line-up and comes with a remote control for single person operation. An additional 5,443kg of counterweight provides a five percent average capacity gain over previous 218 HSL. There is also a new quick reeve boom head with button style termination for easy setup. The boom section on the 218|V is common to 218 HSL. Maximum main boom length is 70 metres and maximum fixed-jib length is 22.8 metres.

NEW G-3 KOBELCO

All of Kobelco's G-3 series crawler cranes have been re-engineered and include a new cab, 362hp Isuzu Tier 4 compliant engines and a new paint scheme. The cab design offers improved visibility and has blue tooth and USB capabilities. All the previous hydraulics, crane travel system and other remain the same together with its standard features including large touch screen LMI, swing limiter, self-erection capabilities, fuel saving G-Modes, KCROSS Telematics, and boom and jib commonality with the previous models.



The new Kobelco CK2000G-3 at Conexpo



The Link-Belt 218|V set up

At Conexpo the company displayed three new G-3 models - the 280ft boom/160 ton CK1600G-3, the 280ft boom/200 ton CK2000G-3 and the 300ft boom/275 tonne CK2750G-3. All three can take a wide variety of attachments including fixed and luffing jib and optional free-fall winch, and feature a high performance tracked undercarriage and hydraulic system and the new operator friendly



The inside of the new Kobelco G-3 cab

ELECTRIC OPTIONS

The developed world's obsession with emission and noise-reducing electric powered equipment continues with more crane manufacturers adding battery electric cranes such as Tadano's 90 tonne GR-1000XL EVolt Rough Terrain unveiled at Conexpo, Spierings and its eLift mobile self-erecting mobile tower cranes along with PV-E and Liebherr Unplugged electric crawler cranes and Sarens 1,650 tonne capacity SGC-90 electric ring crane.

Dutch manufacturer PV-E Crane launched its 160 tonne EC160 crane early last year and followed it up with the 80 tonne EC80 with 37 metre main boom at Bauma. The EC80 is a smaller version of the larger crane with a similar driveline and a 250kW electric motor - with 360kW peak power - and powered by a battery pack of one or two 130 kWh LFP batteries. It is also possible to opt for a larger 195 kWh output XXL battery pack which further extends the running time. "On a full standard battery pack, it is possible to run for eight to ten hours," said managing director Rob van den Boogaard. "It can however be swapped out rather than recharged if the crane needs to work longer."

Sarens' 1,650 tonne SGC-90 electric ring crane



The 80 tonne battery powered PV-E EC80



The PV-E crane battery pack

The new EC series is a range of 100 per cent battery-powered lattice boom and telescopic boom crawler cranes. Lattice boom models will include the EC80, EC90, EC100, EC135 and EC160 with capacities as per the model numbers. In terms of initial purchase price, the company says that the 160 tonne battery electric model will carry a premium of 10 to 15 percent over a diesel equivalent.

PVE gives a 3,000 load cycle, or five year, warranty on the batteries. "The batteries are very efficient charging at 45 kWh per hour from a typical 63 Amp site supply, which means less than six hours to fully recharge the 260 kWh battery from empty to full. The charger is built into the crane, only a charging cable is needed to connect to the supply."

The first EC80 for Dutch contractor Heijmans was equipped with a tilt cab, overpressure system, third winch in the bottom boom section for a vibratory hammer, platforms on both sides of the superstructure, folding railings, 360 degree camera system, central counterweight, toolbox on undercarriage and extra working lights.

"For such a small company, we are well able to offer custom made solutions," said Van den Boogaard. "For example, the EC80 at Bauma had an AC connection in the undercarriage, so it can also be connected directly to a power grid for lifting or slewing. The specs and looks of this crane appeal to customers, and thanks to its good value for money, we expect to sell a lot of them. Both models are available from stock and there has already been interest from the Benelux, England, Scandinavia and Singapore."

Strong like a bull!

The LR 1800-1.0

Suitable for every requirement – its large selection of boom configurations enables the powerful LR 1800-1.0 to deliver the perfect solution for every job. Whether it is in the industrial, infrastructure or wind sector. On top, it provides economic transport – worldwide.

www.liebherr.com

LIEBHERR

Mobile and crawler cranes

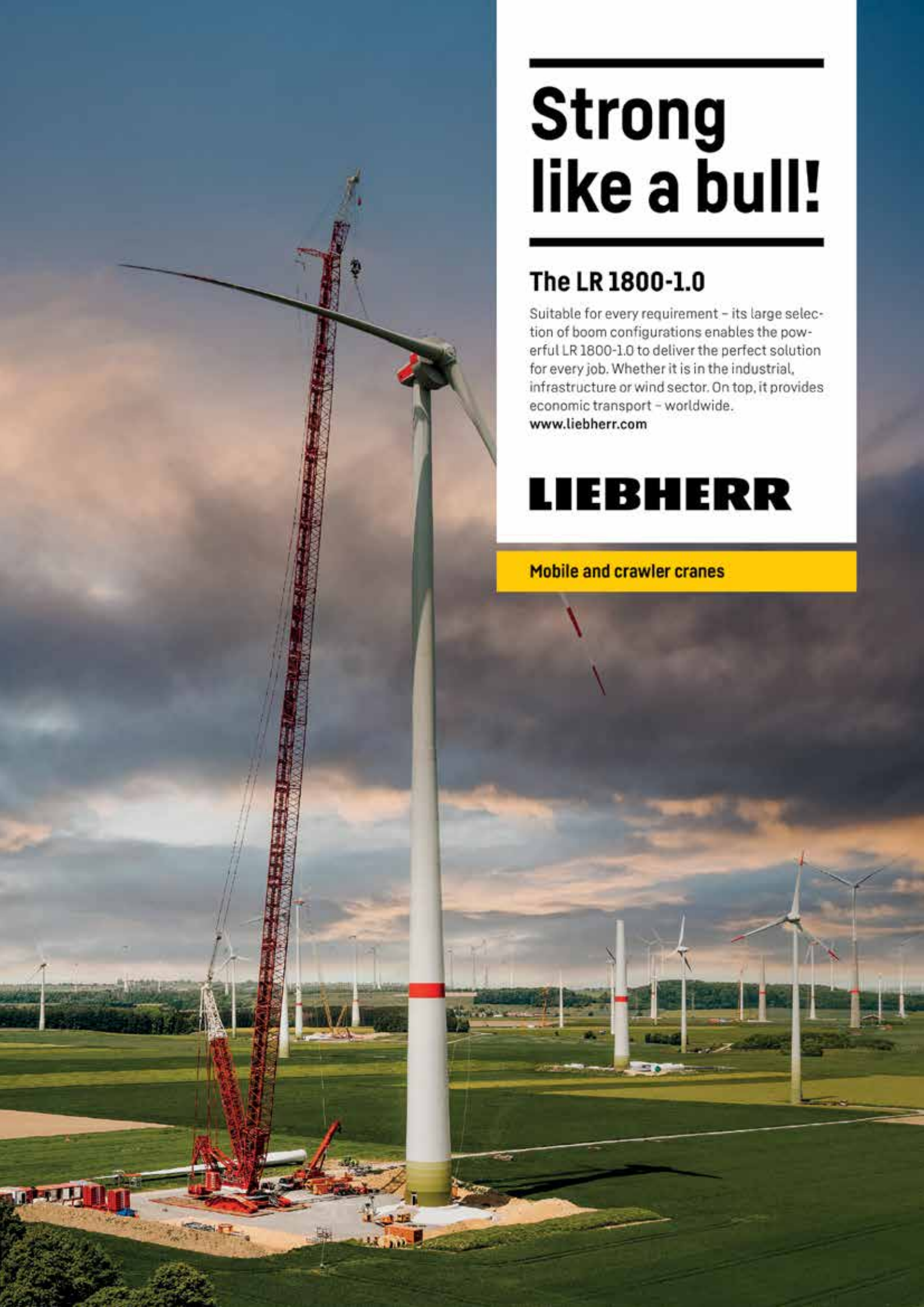

CRAWLER CRANES

LIEBHERR UNPLUGGED

Liebherr launched the first models in its range of Unplugged battery electric crawler cranes - the 200 tonne LR 1200.1 and the 250 tonne LR 1250.1 - at the end of 2021 and since then has added the 130 tonne LR 1130.1 and the 160 tonne LR 1160.1.

The company says that interest in the Unplugged cranes has been high with around 30 cranes sold so far, roughly one Unplugged for every six or seven diesel machines. With the early innovators having already taken delivery, Liebherr expects this ratio to increase but not significantly over the next few years although the growing noise and emissions pressures on

contractors working on inner city jobsites may change that.

So far most Unplugged cranes have been delivered in Europe and Scandinavia in particular. Four units have been shipped into North America, a few to Australia and recently one into Hong Kong. The high battery cost is said to add an additional 25 percent to the price of the crane - although that is set to come down, but when calculated over the life of the machine that investment is likely to be fully recouped. ■



Liebherr has sold about 30 Unplugged crawler cranes to date

NEW 700T LIEBHERR NARROW TRACK CRAWLER

Liebherr has just announced a new 700 tonne narrow-track lattice boom crawler crane - the LR 1700-1.0W - replacing the 600 tonne LR 1600/2-W aimed at the wind turbine installation market. The move follows the introduction of the regular LR 1700-1.0 which replaced the standard LR 1600/2 almost two years ago.

The new crane has new narrow track travel gear with four drive motors and two metre wide track pads as standard. The crane also features a new carbody and cruciform support base, with an overall width of 5.9 metres - only 100mm wider than its predecessor. The supports/outriggers fold to the front and rear when travelling. The superstructure frame and boom systems are basically the same as on the standard 700 tonne crane.

Comparing the capacities with the LR 1600's longest wind turbine boom - 156 metres of main boom plus a 12 metre lattice fixed jib - the LR 1700-1 can handle up to 120 tonnes compared to 73 tonnes on the 600 - a 64 percent improvement. In addition, the new crane can be rigged with between six and 15 metres more reach, depending whether the derrick system is employed. The LR 1700-1.0W can also be equipped with a luffing jib for a lift height of 198 metre allowing it to handle turbines with hub heights of 170 metres. The V-frame and VarioTray systems used on the manufacturer's larger cranes are also available.



Liebherr's new 700 tonne LR 1700-1.0 W replaces the 600 tonne LR 1600/2-W

MAT & TIMBER SERVICES



CRANE MATS
OUTRIGGER MATS

TEMPORARY
ACCESS ROADS

RAMPS

For all types of
cranes under any
application -
Nationwide and
Overseas



TEL: +44 (0) 1264 811005
FAX: +44 (0) 1264 810600

e-mail: info@sarumhardwood.co.uk

web site: www.sarumhardwood.co.uk



A SHOCK TO THE SYSTEM

Last month Vertikal.net reported the death of a 52 year old man working for a telecoms contractor in New Jersey, USA. He was electrocuted after he made contact with a high voltage power line while working from a van mounted lift.

The police statement said: "Hamilton Fire Department was already on the scene attempting to extinguish the fire when they noticed human remains in the fire on top of the box truck. Further investigation determined the deceased was working on fibre optic lines in the area and was electrocuted by a live power line."

A month or so earlier a 24 year old man died in a truck mounted lift in Oakvale, West Virginia, USA after also coming into contact with an overhead power line while installing a new fibre optic cable. As is the case in all such incidents, the fire and rescue services could not reach the man until staff from the utility company arrived and confirmed that the line was safe.

What both of these incidents highlight are just how dangerous it is working near overhead power cables or lines and the simple fact that truck and van mounted work platforms are the access methods most commonly involved in this type of incident due to the applications they are often used - telecom cable installation & repair and street tree pruning etc. In many cases we report - especially with tree work - the operator was unaware of the power line. Given their use in street work, operators of truck and van mounted platforms need to be particularly aware of the problems and how to avoid them.

IPAF's accident report statistics show that in the latest 10 year period, 169 'electrocution' reports were submitted from 12 countries involving 179 people, with 129 fatalities. As if this is not sobering enough there has been a worrying

upward trend since 2015, although that may be down to the IPAF's reporting portal becoming more widely used. What we do know is that these statistics are just a fraction of the actual number as the majority have not historically been posted on the portal.



NO LESS SAFE

While the incidents above give the impression that vehicle mounted lifts are more dangerous than other types of platforms, that on this is not the case. They just happen to be the platform of choice for such work. They are also mostly used on the open highway where traffic and bad drivers are a risk.

A less typical fatality around the same time occurred when a 24 year old man was pulled out of a van mounted platform in Rangeley, Maine, USA. He had remained in the elevated platform while his co-worker drove the rented van mount between two work points. According to the police the man became tangled in some low cross lines suspended over the road - he fell to the ground and died from his injuries. Cables do not have to be live to kill.

As a result of the rising statistics, IPAF launched new guidance at Conexpo - 'The Safe Use of MEWPS in the vicinity of Power Lines'. More details later in this feature.

PRODUCT ELECTRIFICATION

It is slightly ironic that the biggest killer when working with truck and van mounted lifts is electrocution when the most significant



development in the sector is the move towards all electric powered products.

No matter what type of equipment we cover these days, the move to battery power is always at the top of manufacturer's agendas. Vehicle mounted lifts feature a different set of technical issues than other types of lift. On the one hand Gross Vehicle Weight is more critical, due to the need to meet road regulations so less room for a jumbo battery pack. On the other hand, with no drive function to worry about the power demands are lower. On top of that jobs are shorter and

Klubb 100% electric van mount



Proton exchange membrane fuel cell

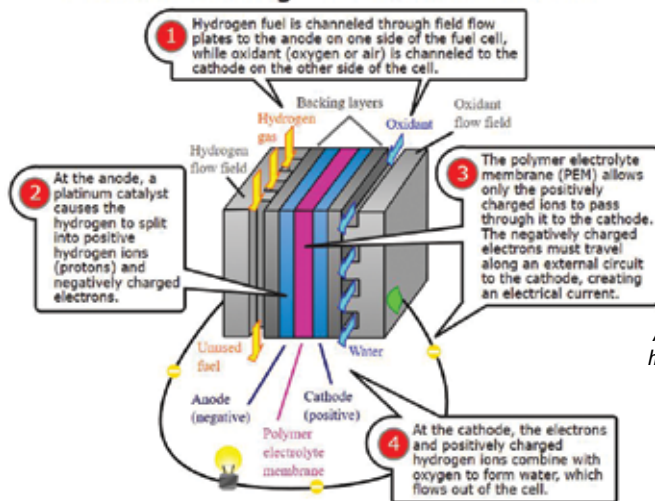

A typical hydrogen fuel cell

usually involve travel between each one - an opportunity for top up charging, assuming it is mounted on an internal combustion powered chassis.

To date, few van or truck platforms have been mounted on all electric chassis, primarily due to the huge cost differential - up to four times the diesel equivalent. Other issues include the additional weight of batteries leaving less available payload for the platform and battery position restricting the installation location of components such as outriggers.

However, more efficient, lighter batteries and a wider choice of suitable electric chassis means more manufacturers are looking seriously at the full electric solution. Some were launched at last year's Bauma where most producers highlighted

all electric models, mostly under 3.5 tonnes - a common size for light commercial van chassis - and a logical place to start with vehicle mounted platform electrification and ideal for inner city applications.

When it comes to medium to heavy truck chassis development lags behind. This may be due to the public charging infrastructure for such vehicles lagging even further behind that for cars. According to the UK's SMMT - The Society of Motor Manufacturers and Traders - there remains considerable uncertainty around the location, type and speed of infrastructure needed for these vehicles with National Grid estimating that 70 to 90 percent of HGV energy provision will be carried out overnight at a depot or destination and only 10 to 30 percent at service stations/truck stops.

Whether or not battery electric powered heavy vehicles will be the long-term solution remains to be seen. Significant development work is also being carried out with hydrogen fuel cell technologies which could prove a viable alternative to batteries for zero emission vehicles.

One example is reach stacker and marine crane manufacturer Kalmar working with Toyota Tsusho America and environmental engineering consultancy Ricardo on a project to develop hydrogen fuel cell powered equipment, starting with its marine terminal tractors. A Kalmar customer in the USA will take two Kalmar Ottawa terminal tractors powered by fuel cell technology for a long-term trial and test. UK based Ricardo is responsible for the design, integration and assembly of the fuel cells which should offer users

feel the **reality**
virtual.digital.original

GEDA
ORIGINAL

**CRANE OPERATOR
HOIST GEDA 2 PK**

The GEDA 2 PK crane operator hoist stands out due to its efficiency, safety and fast rescue capability in an emergency. The crane operator is transported quickly to his workplace in the sky – up to a height of 150 m. The flexible system of the GEDA 2 PK is suitable for all types of cranes from all manufacturers.



Order the new
GEDA catalogue for free





A Kalmar Ottawa terminal tractor

extended operational time and reduce the need for new investment in the electrical infrastructure.

NEW PRODUCT ROUNDUP

ALL ELECTRIC CTE

CTE announced several new products at Bauma last October, including its 20 metre all-electric MP 20Ev mounted on a 3.5 tonne chassis. The platform uses a single fixed riser, two section telescopic boom and articulating jib for 13 metres of outreach and 250kg platform capacity. Overall width is just under 1.6 metres, with an overall length of 5.2 metres, while easily clearing a two metre overhead restriction. Power is supplied by a 35kWh Webasto lithium ion battery - which is Li-ion NMC - R100 certified and capable of travelling 70km and completing 25 full work cycles on a single charge. The machine has an onboard charger and can also work while plugged into a mains outlet.

The lower control console is linked to a wireless



CTE's 20 metre all-electric MP 20Ev mounted on a 3.5 tonne chassis

remote with integrated display, while the upper controls have the same look and feel of the ground controls for ease of operator training and familiarisation, while the company's advanced S3 EVO management control system is standard. The project was developed in partnership with Green-G Electric Vehicles of Gorizia, which produces zero emission electric commercial vehicles under the 'ecarry' name.

THE FUTURE 'ZED'

CTE has also launched the totally new 22 metre, Zeta 22 which slots into its range between the Zed 21.3 and Zed 23.3. It is the first model in a brand-new range of articulated truck mounted platforms which will take over from the highly successful 'Z' models which began in 1993 with the Z-16, followed by the hugely popular Z-20 in 1996. The 'Z' nomenclature was changed to Zed in 2009, while the 10,000th Z/Zed 20 was shipped in September 2015.

Mounted on a 3.5 tonne Isuzu or Iveco chassis, the Zeta 22 features a dual sigma type riser - the



The totally new 22 metre, Zeta 22 slots between the Zed 21.3 and Zed 23.3

lower arm being shorter than the upper - with the two connected by a boomerang shaped linkage. The riser is topped by a three section telescopic boom with an end mounted platform. Maximum outreach is 10 metres with 100kg, at an up & over height of 9.8 metres, while 8.5 metres outreach is possible with 200kg, and the maximum platform capacity of 250kg can be extended to 7.5 metres.



Maximum outreach is 10 metres with 100kg at an up & over height of 9.8 metres

VERTIKAL DAYS
PETERBOROUGH
10TH/11TH MAY
2023

STAND NO. 600

B240PX XEV

GSR SpA

| Via Lea Giaccaglia, 5 - 47924 Rimini (RN)

| Italy +39 0541 397811

| sales@gsrspa.it

| www.gsrspa.it

TRUCK MOUNTS

The Zeta 22 is also equipped with CTE's S3 EVO platform management system, while the outriggers are variable with a minimum footprint of 2.3 metres by 2.44 metres long extending to 2.54 x 2.94 metres, with automatic monitoring and work envelope adjustment. Options include a wired remote control for all functions, with a seven metre cable and an 'automatic boom return to stowed position' button. A fully integrated cloud-based telematics system is also available.

90 CTE TRUCK MOUNTS FOR SMART

UK based rental company Smart Platforms ordered 90 CTE 3.5 tonne truck mounted lifts in a deal worth more than £7 million. CTE UK's largest order to date includes the 20 metre Zed20.4HN, the 23 metre Zed23.3JHL which has one sided narrow jacking, 10 metres of outreach and 250kg platform capacity. The order also includes several units of the all new 24 metre MP24C with twin telescopic booms articulating jib and up to 14 metres of outreach which was launched at Vertikal Days last year.



The all-new 24 metre CTE MP24C

ALL-ELECTRIC RUTHMANN

Bauma also saw Ruthmann announce a larger all-electric truck mount - the 26 metre Ampero TBR 260 E - mounted on the new battery powered Iveco eDaily 5.2 or seven tonne chassis, with a 74kWh battery pack offering a combination of up to 150km of travel and 30 full working cycles on a single charge. The battery pack can be fully recharged from empty in an hour when using an 80kW fast charger or four hours on a standard 22kW charger.

The TBR 260E is similar to the standard TBR 260 with up to 17 metres of outreach over the rear



The 26 metre Ampero TBR 260 E can be mounted on the new battery powered Iveco eDaily 5.2 or seven tonne chassis



The first Ruthmann T300 XS Hybrid to be delivered

and 100kg in the platform, or 14 metres over the side. The maximum platform capacity is 250kg with the 700mm by 1.4 metre platform. A 1.6 metre wide platform with 300kg platform capacity is optional.

Ruthmann has also delivered its first 7.5 tonne, 30 metre T300 XS Hybrid truck mounted platform to German rental company Gerken. Launched at Bauma it features a five section telescopic boom topped by a jib with up to 185 degrees of articulation, providing up to 23 metres of outreach with 100kg or just over 17.5 metres with the maximum platform capacity of 350kg. The choice of 7.5 tonne MAN or Iveco chassis is available - both diesel powered - while the superstructure is powered by a 12.8kW lithium battery pack - good for up to 13 full working cycles - and can be recharged by the truck engine when travelling between jobs or simply plugged into a mains outlet with a full recharge taking four hours. It can also operate as a normal machine from the truck's PTO pump. Function speeds are said to be close to that of the standard diesel model.



The T300 XS Hybrid control station

TIME EXPANDS FURTHER

Ruthmann was of course acquired by Time Manufacturing a couple of years back. The group's acquisition trail has continued with French truck and van mounted lift manufacturer France Elévateur and its Spanish affiliate Movex acquired last June. Versalift International's managing director Kim Bach Jensen heads the group's expanded operations in Europe which also includes Versalift, Time International, Ruthmann and Bluelift.



The Time team at Bauma (L-R) Charles Goffin FE, Martin Christiansen Versalift Europe, Uwe Strotmann Ruthmann, Jay Jeffrey president of Time and Kim Bach Jensen Time Europe

France Elévateur - or the FE group - was founded in 1984 in Flavigny-sur-Moselle, eastern France and produces a range of truck and van mounted aerial lifts ranging from standard rental models to fully insulated custom builds. It acquired Spanish truck mounted lift manufacturer Movex in March 2021. The deal also includes wholly owned distribution outlets - FE Benelux and FE Deutschland.

The addition of FE and Movex puts Time Manufacturing at the top of the global vehicle mounted lift market and the dominant player in some European market sectors. The acquisitions take the group well beyond the \$500 million revenue level however it still has plenty of strong competition particularly from France's Klubb - which was set up by Julien Bourrellis from the Time licensee Time France in 2015. Over the past year it has continued to expand through several acquisitions including Italian manufacturer Isoli in October.

KLUBB'S RAPID RISE

Klubb began manufacturing its van mounts in January 2016 and has since expanded at a rapid pace, both through organic growth and



No matter your specialisation, you deserve our special attention.

The same dedication that we attribute to the manufacturing of our aerial platforms. No less than 14 models divided into six families, designed to respond perfectly to your requirements and your specific professional needs: **from tree care to the maintenance of buildings, installations and infrastructures; from restoration to work on high-voltage lines.**

Discover the advantages of the CMC range on our website.

CMC
THE SPECIALIST

www.cmclift.com

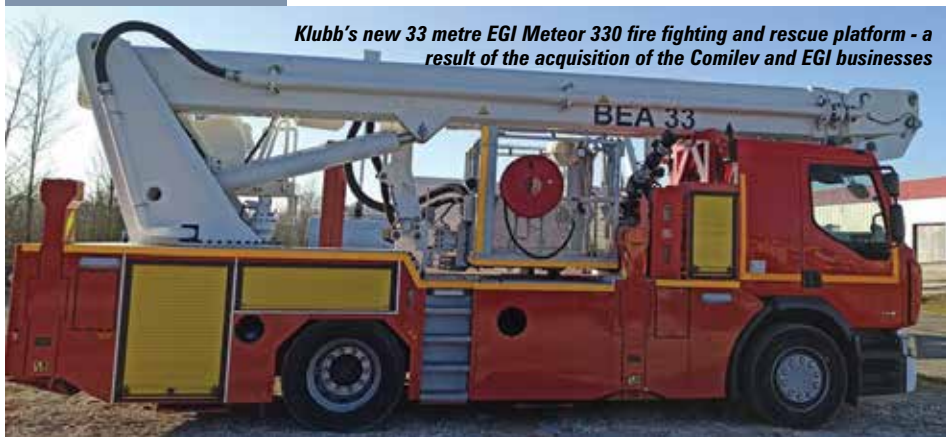

Klubb's new 33 metre EGI Meteor 330 fire fighting and rescue platform - a result of the acquisition of the Comilev and EGI businesses

acquisitions. In 2017 it added French van and vehicle mounted lift manufacturer Comilev and the following year its UK dealer CPL which also built van and pickup mounted platforms. Later that year it added French specialist platform manufacturer EGI.

The company secured an injection of capital from private equity firm Andera Partners in July 2021, allowing it to step up the pace still further, acquiring Italian manufacturer Isoli adding both the aerial lift and recovery truck manufacturing operations as well as its 77,500 square metre purpose-built plant in Fontaniva - between Verona and Venice - with around 120 employees.

Isoli was founded in 1946 by the Isoli brothers to design and manufacture aerial work platforms, tow trucks and special equipment including cranes and military recovery equipment. Klubb - and its previous incarnation Time France - was the Isoli distributor for France since 2006.

Klubb's founder and majority owner Julien Bourrellis said: "We have been the Isoli dealer since 2006, so it was natural for us to go further. It is a really nice brand which needs to be refreshed and all my team is really excited by this project. Klubb is probably number one in market share on the utility sector in Europe but not yet in the rental market. Isoli will help us to develop sales to rental companies."

NEW 29M ISOLI

A few months prior to its acquisition Isoli

launched the new 29 metre PNT 290 articulated truck mounted platform on an 11 tonne, two axle chassis. The new lift employs a classic dual sigma type riser topped by a four section telescopic boom with internal extension mechanism and power track, with brush type debris protectors between sections. It offers a maximum outreach of 16.5 metres at an up & over height of 12 metres with its unrestricted platform capacity of 250kg and a 2.2 metre by 750mm top mounted basket/platform.

Slew is 400 degrees, while the aluminium basket has been designed to be quickly and easily removed and stowed on the deck to reduce

the overall length when required. It can also be replaced with a lifting hook for light duty crane work. The overall stowed length is 8.1 to 8.2 metres depending on the installation, with an overall height of 3.43 metres.

As part of the Klubb group Isoli has access to Klubb's hybrid and all-electric van mounted range - a type of platform not that popular in Italy. Most of the Klubb van mounted platforms do not require stabilisers, making them ideal for short repetitive tasks such as street lighting maintenance or telecoms. Isoli now offers the complete set of van platforms from the KL21B on a Renault Trafic chassis up to the K42p on a Renault Master.

CPL - Klubb's UK subsidiary - says that it continues to see a sharp rise in demand for Klubb's fully electric KL26 Renault Master ZE with more than 100 currently on order, in build or being delivered. CPL - which claims market leadership in the UK - says it has worked with Renault Trucks to ensure the base vehicle has the autonomy and correct weight class to function as a practical commercial aerial work platform.

CPL also offers a 20 metre articulated platform on a 3.5 tonne chassis, with a maximum outreach of 8.4 metres and sits alongside the Palfinger P200 - also distributed by CPL in the UK - as a midrange option. The company has added to its



The Palfinger P250 is distributed by CPL in the UK



Isoli's new 29 metre PNT 290 articulated truck mounted platform on an 11 tonne, two axle chassis

VERSALIFT

VTL ALL-ELECTRIC

ELECTRIFYING PERFORMANCE



There's a sense of great excitement at Versalift as the new VTL All-Electric hits the road. With its 100% electric boom and the new All-electric Ford E-Transit, this urban duo takes the lead in electrifying performance, without compromise.

A new boom, higher payload, no stabilisers, impressive range on full-charge, plus reduced maintenance costs, all work together to optimise your productivity.

Look out for the new VTL All-Electric at Vertikal Days Stand **410-412**



600kg
payload



Best in
class driving
range



e-Tech battery
technology for low
emission zones



Working
height 13.5m



8m
outreach

VERSALIFT

Versalift United Kingdom
01536 721010
sales@versalift.co.uk
versalift.co.uk

Versalift Ireland
0818021092
sales@versalift.ie
versalift.ie



The aluminium basket can be removed and replaced with a lifting hook for light duty crane work



The 10.7m KL26 mounted on the Piaggio Porter NP6 offers a dual fuel petrol/LPG or petrol/NGV

sales team in the past year with a dedicated team for Palfinger Platforms which range from the 3.5 tonne P220, P250 and P280 to 90 metre truck mounts.

Other recent Klubb launches include the K20L and KL21B on the e-Expert van, and the Klubb KL26 on Piaggio Porter NP6. Equipped with a 75KWh XL battery pack, the Klubb K20L is mounted on the cutaway e-Expert van - requires no stabilisers - and has a claimed travel range of 330km in addition to 32 work cycles in electric mode. It is compact at just 5.5 metres long and has a 10.5

metre working height and 5.8 metre of outreach, making it ideal for work in confined areas, such as underground car parks, inner city streets and pedestrian only zones etc... It is finding a good following among companies installing and maintaining CCTV as well as local authorities.

The slightly larger KL21B - also mounted on the e-Expert chassis - has an 11.4 metre working height and 6.4 metres of outreach yet features adequate storage capacity and payload to transport sufficient tools and equipment. Road range is less at 230km, while the 32 work cycles

remain. The model is also available in a diesel version with a Green Pack, which allows the aerial work platform on battery power while the vehicle's engine switched off.

The KL26 mounted on the Piaggio Porter NP6 offers a dual fuel petrol/LPG or petrol/NGV (natural gas vehicle). It has a working height of 10.70 metres and a six metre reach.

LIVING DECK MATERIAL

One highly unusual, original and innovative exhibit on the Klubb stand at Bauma - was a small pickup



socageworld.com





At Bauma Klubb showed a small pickup mounted lift with bamboo decking while bamboo tool boxes are also in development

mounted lift with bamboo decking, while bamboo tool boxes are also in development. The bamboo is actually marginally lighter than the aluminium that it will replace, but most importantly is dramatically more sustainable. Klubb is sourcing locally grown bamboo, with the manufacturing carried out close to its production facility. Bamboo grows rapidly and can be harvested regularly, while requiring very few resources. It is also biodegradable.

BRONTO HYBRID

Finnish truck mounted lift manufacturer Bronto Skylift unveiled its prototype Hybrid Pack concept for its truck mounted work platforms at Bauma, displayed on a compact 35 metre S35EM. It utilises a lithium-ion battery pack, feeding an electric motor which drives the main hydraulic pump. The battery is said to be sufficient to power the machine for a typical working day. However, if the battery is low, the lift can still be operated via the chassis' PTO pump.

Bronto has had a number of recent sales successes with its smaller models, where it has to do battle with Italian manufacturers as well as the two leading German players. UK rental company Nationwide Platforms - part of the Loxam group - for example has ordered six of its 38 metre S38XDTs as well as two more 35 metre Bronto S35EM's mounted on Scania Low Cab L320s for urban applications, which join eight units already delivered. It also added two 56 metre S56XR's.

The S38XDT features a three section telescopic boom topped by a two section jib and articulating end jib for a maximum outreach of 25.3 metres with 120kg in the platform, while the maximum platform capacity of 600kg is available at up to 21 metres. The S56XR features a four section boom, topped by a similar jib arrangement to the S38 XDT. Maximum outreach is 37.3 metres with 200kg, while the maximum of 600kg is available at up to almost 32 metres.

NEW IPAF GUIDANCE ON THE SAFE USE OF PLATFORMS NEAR POWER LINES

Aware of the increasing occurrence of fatal incidents with truck and van mounted aerial lifts working near overhead power cables, IPAF has launched a new guidance document 'The Safe Use of MEWPS in the vicinity of Power Lines'. It launched the new initiative at Conexpo and promoted it through a series of live demonstrations showing the dangers of working near power cables.

Electrocution and electric shocks are sometimes spoken of as being one and the same thing - especially by local newspapers - but clearly this is not the case. Electrocution invariably involves death, and electric shock can leave a person with very serious injuries or none at all, depending on the voltage, the current and conditions.

IPAF puts it in greater detail and precision:

Electrocution is when a person dies because of contact with electricity such as accidental contact or the arcing or flashover from a power line. A flashover is a high-voltage spark or arcing that passes through the air between an electrical conductor and a grounded conductive object. Potential flashover distance is the distance that an arc can travel through free air and depends on the voltage and environmental conditions. High humidity can cause the flashover distance to increase as moisture in the air conducts electricity.

S3 EVO

A SIMPLE SOLUTION ALWAYS HIDES A GREAT IDEA

2023 MAASTRICHT 4th 6-8 JUNE

STAND 1480 Outdoor Area

CTE MP 20 Ev

PERFORMANCE:
WORKING HEIGHT: 20 M
OUTREACH: 13 M
CAPACITY: MAX 250 KG
GVW: 3.5 T

A GREEN AND SILENT REVOLUTION



100% Electric

- ✔ Zero emission
- ✔ Zero noise
- ✔ Full productivity

www.ctelift.com





Bronto Skylift unveiled its prototype Hybrid Pack concept for its truck mounted work platforms at Bauma

An electric shock occurs when a person comes into contact with an electrical energy source and electricity flows through a portion of the body causing a shock. This may result in no injury at all or may result in devastating damage, possibly leading to death. Victims of electric shocks often suffer life-changing injuries such as amputation, severe burns, brain and/or other nerve damage.

From the IPAF statistics generated from its global accident reporting portal, the top three industries globally for electrocutions and electric shocks are arboriculture - tree work - the electrical supply and maintenance sector and construction. Most incidents occur in public areas on or adjacent to highways and construction sites. Data also shows that non-electrical workers - those not directly employed or subcontracted by energy

reveal a lack of planning. This may be either a failure to identify the presence of power lines within the work area, the incorrect choice of access platform/work at height equipment, untrained operators and/or lack of machine specific familiarisation.

Failure to identify power lines can be fatal, while failure to understand and respect the risk of electrocution from power lines also puts people at risk. Electricity is invisible and when contact or arcing occurs, temperatures can be extreme, often leading to severe burns.

The message is clear: never take short cuts, if something isn't right - stop! Make sure everyone is trained - managers, supervisors, operators, spotters - and always have a healthy respect for power lines and the risk of electrocution or shock.

For further information search IPAF Safe Use of MEWPs in the Vicinity of Power Lines which has much more information on how to work safely near power lines. ■

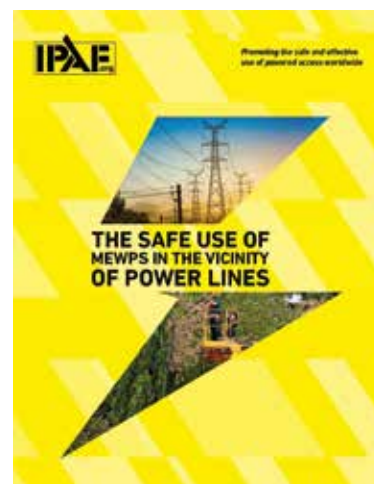
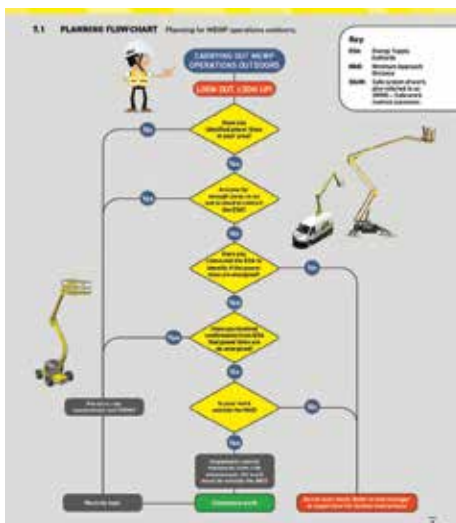

A Nationwide Bronto S35EM working in Regent Street, London

10.-11.05.2023
at Vertikal Days in Peterborough

FULLY ELECTRIC



The new AK 48e* First fully electric truck crane in steel-aluminium design

The AK 48e starts a new era and combines powerful crane technology with completely emission-free and low noise electric drives. Built on a Mercedes eActros, the 27 t carrier travels to site battery-powered and also works

totally electrical on site - in crane and platform mode.
For a sustainable future.



LEGUAN[®]

leguanlifts.com



REACH THE NEXT LEVEL

225

Meet the Leguan 225

Get ready for the next generation of spider lifts. With faster boom hydraulics, greater working height, unrivaled up-and-over reach, and ground-breaking joystick controls, the Leguan 225 is our most advanced spider lift to date. User friendly design, improved driving features and a steel-reinforced chassis guarantee premium performance even in the roughest terrains.

Vertical
days

VISIT
LEGUAN LIFTS
AT STAND 604

PART OF
AVANT
GROUP

10th-11th
May 2023

Vertikal days

THE VERTIKAL
GUIDE FOR
BUYERS AND
USERS OF LIFTING
EQUIPMENT



OVER 270
BRANDS ON
DISPLAY
Register to
attend today
[vertikaldays.net](https://www.vertikaldays.net/visitor)
/visitor



Come see us at our stand at the Vertikal Days trade show – MP24



ACCESS PLATFORM

DEEP CYCLE & STARTER BATTERIES



**MAINTENANCE
FREE BATTERIES**

REDUCTION IN DOWNTIME AND COSTS

**INCREASED CYCLIC
CAPACITY**

REDUCING WHOLE LIFE
COST OF THE BATTERY

FULL RANGE

INCLUDING
DEEP CYCLE FLOODED
& AGM CARBON LEAD
TECHNOLOGY

**MARKET LEADING
SPECIFICATIONS**

PREFERRED CHOICE FOR OEM MANUFACTURERS

For more information contact our
customer services team on: 0161 971 5000

PLATINUM
INTERNATIONAL

ALLIANCE
AUTOMOTIVE GROUP

VERTIKAL DAYS 2023 - FULLY LOADED



Vertikal Days returns to the East of England Showground, Peterborough on Wednesday 10th and Thursday 11th May with a supersized show with more than 270 exhibitors and brands making it the biggest gathering of cranes, aerial work platforms, telehandlers and associated equipment and services since the exhibition began in 2007.



ALL INCLUSIVE

As in previous years, everything at the event is complementary for visitors - parking, admission and refreshments throughout the day including a substantial lunch.

This year there are 27 new exhibitors making it one of the most diverse lifting equipment gatherings anywhere. And in spite of Bauma and Conexpo taking place over the past six months or so, Vertikal Days will still host several worldwide and European product launches, while serving as the UK launch pad for a large number of new products.

The show continues to grow and 2023 looks set to attract an even wider range of senior level staff from rental companies, contractors - both specialist and major - utility companies and all manner of end users.

SPECIALIST EVENT

Vertikal Days is a specialist event for professionals who use or work with lifting or work at height equipment. The event focuses on attracting influential and relevant visitors - industry 'movers and shakers' - rather than visitor numbers. For many attendees, knowing that everyone on the showground shares the same interests is what makes it so special. With so much to see and so many people to meet, it is worth staying over for day two.

SHOW INFORMATION

- Venue:** East of England Arena and Events Centre, Peterborough, PE2 6XE, UK
- Show times and dates:**
Wednesday 10th May 10:00 to 17.30
Thursday 11th May 10:00 to 16.00
- How to register**
 - Pre-register: www.vertikaldays.net/ visitor and print visitor badge





TECHNICAL TRAINING COURSES



Discover the
different possibilities:



Virtual 'How-to'
sessions of 1,5h



Digital packages:
e-learning +
live virtual training



In-person training classes



Tailor-made training sessions
at a location of your choice



TVH UNIVERSITY

Contact us for
more information:

E technicaltraining@tvh.com
T +32 56 43 44 38

**VISIT US ON
STAND 510.**

TVH PARTS NV

Brabantstraat 15 • 8790 Waregem • Belgium
T +32 56 43 42 11 • F +32 56 43 44 88 • info@tvh.com • www.tvh.com

KEEPS YOU GOING.

THE MARKETPLACE - A SHOW ON ITS OWN

In the centre of the showground is the Marketplace which is bigger than ever this year, with almost 50 companies displaying everything from software to overload systems, under the hook products, batteries, telematics and replacement parts, as well as hosting insurance, training and finance specialists. While the scale of the impressive equipment on the outdoor stands is hard to ignore, the Marketplace is well worth spending time, grabbing a coffee and a pastry in the Marketplace Café and having a good browse. It is also an ideal location to meet up.

MAKE A MEAL OF IT

Located at the top end of the showground, the Catering Pavilion serves lunch each day between 12.30 and 14.30. It is the perfect place to 'network' over a hot meal. Catering includes the now traditional free-range hog roast, barbecue and a range of vegetarian and vegan alternatives. For those on a tight time schedule there is also a fresh sandwich bar.

NETWORKING EVENT

This year's networking evening event on Wednesday evening has an Italian theme and as always requires a ticket to attend. It is also held in the Catering Pavilion and will follow on from the early evening reception which kicks off at 17.30 in the StarShade, immediately adjacent to the Pavilion. It is a perfect time for exhibitors and guests to unwind after a long day at the show and catch up on the day's events with some good music, food and drink.

If you are staying for the evening event and/or returning to the show on the Thursday, there are a multitude of hotels within a five mile radius. We would however recommend booking as soon as possible. A complementary shuttle bus service runs between the local hotels before and after the networking event.

AND FINALLY...

In recent years sponsorship has helped the organisers hold down the cost to exhibitors in the face of rising visitor numbers and escalating supplier costs. This year the organisers would like to thank: Liebherr for providing the sustainable show bags, Versalift for the Marketplace coffee cups and TVH for providing bottled drinking water and outdoor maps. At the entrance IPAF is sponsoring the visitor badges and Point of Rental the lanyards. First time exhibitor Infosystem is sponsoring the lunchtime BBQ while CTE is sponsoring the Networking dinner. The forklifts for the free offloading and loading service during build up and tear down will once again be provided by Hi-Tec/Briggs, with City Traffic Management providing traffic signage and Speedy Services is sponsoring the Tower Lights. A big thank you to you all!



A BIG THANK YOU TO OUR EVENT SPONSORS:



E-TECH

HIGHER STANDARDS



JCB has used their experience in designing tough, hardworking equipment to ensure their electric scissor range is also built to higher standards. With a high quality paint finish and many unique features, the machines have higher levels of safety, ease of use, reliability and serviceability. Industry standard components across the range allow seamless integration into existing rental fleets. JCB also offers higher levels of support through an unrivalled dealer network, with quick start guides, good parts availability, finance and technical advice.



For more information, please contact your local dealer or call 0800 581 761.

See us at Vertical Days - Visit us on stands 406/506 www.jcb.com

ACCESS EQUIPMENT AND TELEHANDLERS

Access Platform Sales (APS): Stand 200/300/400/500

APS will exhibit equipment from all of the major brands it represents including Hinowa, LGMG, BoSS and Wienold. New models on the stand will include the 40 metre Hinowa LL40.18 spider lift, the recently launched LGMG M0407TE mast boom, SC0407E electric scissor lift and H1840 telehandler. Also on the stand will be a range of material handling products from Wienold, a BoSS PA Lift and Nolim outrigger pads.



On the stand: LGMG M0407TE, LGMG SC0407E, LGMG H1840, Hinowa LL40.18

AJ Access Platforms: Stand 102

UK based AJ Access Platforms is the UK distributor for Zoomlion aerial work platforms. The company says that it will use the show for a number of UK debuts including several new scissor lifts, a crawler, a micro slab electric and Rough Terrain scissor model. On the boom front it will launch both articulated and straight telescopic models.



Alfa Access Services: Stand 404

Alfa Access Services - the UK distributor and service agent for Teupen spider lifts, ELS Lift scissors and booms, Omega Solutions heavy duty self-levelling tracked scissor lifts, Mecaplus self-levelling Rough Terrain boom lifts and Bravi low level platforms and stock pickers - will have a selection of new equipment on its stand including Teupen's 30 metre Leo 30T Plus and 21 metre Leo 21GT, plus the new ELS VM6 mast type lift and 5.5 SP as well as a Pilotcar P1000. The



company will also promote its LOLER inspections, major repairs and refurbishment, on site repairs, operator training and spare parts services.

On the stand: Teupen Leo 30T Plus, Teupen Leo 21GT, ELS Lift VM6, ELS Lift 5.5 SP, Pilotcar P1000

Alimak: Stand 601

Alimak will show several new and improved products on its stand including the brand new latest generation Scando 650a construction hoist. The company will also unveil its 'My Alimak' customised web based portal. The show will also see the UK debut of the TPL 2.0 Transport Platform which has been improved and upgraded, displayed alongside the Scando 650 XXL Construction Hoist.

On the stand: Alimak Scando 650 XXL, My Alimak, Alimak TPL 2.0, Alimak Scando 650a



Scando 650 XXL

Almac: Stand 503

Italian manufacturer AlmaCrawler produces self-levelling, self-propelled tracked aerial work platforms and will use Vertical Days for the UK launch of the Jibbi 1890 PRiMO - its first full electric 18 metre working height boom lift. The company will also display several new products from its tracked carrier and material handling line.

On the stand: T-Crane 1060, ML 3.0 FX, Bibi 870, Jibbi 1670 EVO, Jibbi 1890 PRiMO

AlmaCrawler: Access Stand 504/505 See CPL

Alp Lift: Stand 215

First time exhibitor Alp Lift is planning to use the event for two European launches - the new 650kg capacity material lift XL400 and its one person, self-drive 12 metre working height AMWP 12 vertical mast lift. Also on the stand will be manual and electric material lifts and an Air Hoist.



On the stand: Material lift S400, electric material lift LE620, material lift XL400, vertical mast lift AMWP 12

ANC Access: Stand 305

See RAXTAR

Avant Tecno: Stand 604

See Leguan

Bluelift: Stand 410/411/412

See Versalift UK

Böcker UK: Stand 107

Böcker will display a range of its latest aluminium and lightweight truck mounted cranes, alongside its hoists, for which there is a growing demand in the UK. They will include the trailer mounted 'Simply' inclined lift and the Top-Lift ladder lift.

BoSS: Stand 400/500

See Access Platform Sales (APS)

Bravisol/Bravi Platforms: Stand 401

Bravi Platforms will demonstrate its 4.9 metre Leonardo HD vertical mast lift with dual roll out deck extensions and 180kg unrestricted platform capacity. You can also see its all electric drywall lifting attachment 'Solo-Gyps' together with the UK debut of the new inspection device - Small-E - which it says, can simplify and improve safety when working in tight areas with suspended ceilings.

On the stand: Leonardo HD, Small-E and Solo-Gyps



Bravi Solo-Gyps

Bronto Skylift



Bronto Skylift: Stand 606

Bronto Skylift will launch its 'Bronto One' cloud-based portal with a 'full visual overview of an owners resources, performance and abilities'. The portal can also access Bronto's aftersales services from anywhere in the world.

In terms of platforms, the company will show a 47 metre S47XR and 38 metre S38XDT which will be equipped with a 360 degree rotation camera platform/cage. Another handy programme is its new 'Bronto Skylift Stock Programme' which allows buyers to view delivery times for its various models.

On the stand: S38XDT with Rotating Camera Cage, S47XR, Bronto One

CLM Construction Supplies: Stand 603

CLM Construction Supplies will show a number of Maber rack & pinion hoists including the MB 500, MB C 1000 and the MB C 2000. The MB 500 is available in a single phase version with a capacity of up to 300kg or 500kg in the three-phase version. The MB C 1000 has a capacity of up to 1000kg with lifting speeds of up to 24m/min. The MB C 2000 has a capacity of up to 1500kg and a maximum anchored height of 150 metres. The largest hoist capacity is two tonnes.

On the stand: Maber MB 500, MB C 1000, MB C 2000



Maber hoist

CMC Lift UK: Stand 313

Italian spider lift manufacturer CMC will have four platforms on its stand - the 15 metre S15 which it claims is the most compact machine in its class - the new MY 18 metre S18F with radio controlled tracking and auto levelling, the 23 metre S23 - the company's largest road towable spider lift which is light enough for a standard two axle equipment trailer and the new 30 metre S30.



CMC MY S18F

On the stand: CMC S15, CMC MY S18F, CMC S23, CMC S30

Comet: Stand 408:

See: Hydraulic Platform Services

CPL: Stand 504/505

CPL - part of the Klubb group and distributor for Dinolift, AlmaCrawler, Palfinger and Isoli - will show a range of platforms from its suppliers including the Klubb KL26 electric van mount on a Renault Master ZE, and the compact Klubb KL21B mounted on a Renault Trafic van. Italian truck mounted lift manufacturer Isoli was recently acquired by Klubb, so CPL will display a 20 metre truck mounted lift from the Isoli range. CPL plans to market them in the UK as CPL/Klubb products.

From Palfinger truck mounted platforms CPL will show a diesel P280 with a retrofit battery pack and while Dinolift has its own stand (309), CPL will also show some models picked specifically for the UK market. AlmaCrawler products will also be on display.

On the stand: Klubb KL26 Renault Master ZE, KL21B Renault Trafic, Palfinger P280, AlmaCrawler Primo

CTE UK: Stand 101

The main new product launch on the CTE stand will be the 20 metre all-electric MP20EV truck mounted lift, mounted on a purpose-built, all-electric 3.5 tonne chassis. This will be its first appearance in the UK since its launch last year. The company will also show the all-new 27 metre

T270 Traccess spider lift, the latest and largest model in the new CTE line-up. Also on display will be the recent addition to the company's 3.5 tonne truck mounted range, the 24 metre MP24C.

On the stand: MP20EV, T270 Traccess, MP24C

Dingli UK: Stand 602

China's leading aerial lift manufacturer will use Vertikal Days for the first outing in the UK for its all-new line up of 'Oil Free' slab scissors. The range now extends from five to 10 metres. If you have not seen them before then this is a must see. Also on the stand will be several new articulated boom lifts, with working heights of 16 to 20 metres, all of which are available with a choice of diesel, battery and hybrid power. Expect to see several models from its range of heavy duty, high and narrow 'Super Scissors' with working heights from 22 to 32 metres available in both slab electric and Rough Terrain formats.

Dinolift: Stand 309



Dinolift will make a number of UK product launches at Vertikal Days including the 28 metre all electric Dino 280 RXTE lightweight self-propelled boom lift, the 21 metre 210XTB trailer lift and 22 metre 220 XTC tracked boom lift with special trailer for easy road transport. It has an overall weight of just over three tonnes, a maximum outreach of 11 metres with 215kg in the platform, and can jack itself up to a height of one metre allowing a small truck or trailer to reverse under it for easier loading and unloading.

On the stand: Dino 280 RXTE (AGM), Dino 210XTB and Dino 220XTC+ trailer

Dino 220XTC



CTE T270 Traccess

The UK's Official Supplier



MB 500/120

Capacity: 300-500kg
Cage Size: 1500 x 1300mm
Lifting Speed: 20m./min



MB C 1000/150

Capacity: 1000kg
Cage Size: 1400 x 1750mm
Lifting Speed: 12/24m./min



MB C 2000/150

Capacity: 2000kg
Cage Size: 1500 x 3200mm
Lifting Speed: 12/24m./min

Contact Us:-

sales@clm-supplies.com

01902 498915

clm-supplies.com



Easy Lift: Stand 209

See Independent Access Sales

Electroelsa: Stand 605

Italian mastclimber and hoist manufacturer Electroelsa will show several new material hoists and mastclimbers on its stand - all with overload system safety devices and remote control. Electroelsa prides itself on the fact that its products are made entirely inhouse at its facility in Italy including all electrical components.



ELS Lift: Stand 404

See Alfa Access Services

Faresin: Stand 206/308

See GGR Group

France Elevateur: Stand 410/411/412

See Versalift UK

Geda: Stand 502

See Mace Industries

Genie: Stand 207/208

See Workplatform

GGR Group: Stand 206/308

As well as its crane and glass handling products, GGR's packed stand will include the UK debut of the 17 metre/4,500kg Faresin 17.45 full electric telehandler - the world's first 17 metre straight frame battery powered telehandler.

On the stand: Faresin 17.45 full electric telehandler



Goman Lift: Stand 302B

Goman Lift is making its UK debut at this year's Vertikal Days and will have three platforms on display - the 28ft S08C tracked scissor lift, alongside two spider lifts.

The S08C offers a 10.5 metre working height and is based on the company's well proven S08 slab scissor. It features lithium battery power alongside an AC mains power unit should the battery be exhausted. Both have a 900mm deck extension and dual axle automatic levelling.

The 21 metre X21 and 18.3 metre X18 spiders are Goman's best sellers and come with three power sources - a petrol engine for the X18 and Yanmar diesel for the X21 alongside lithium battery and AC motor power packs. Both models feature a galvanised boom, height and width adjustable crawlers, radio control and cable connector.

On the stand: X18 and X21 tracked spiders.

GSR: Stand 600

GSR will show several of its 'PX' articulated truck mounted platforms including the 20 metre B200PX, the 24 metre B240PX and the 22 metre B220PXE with end mounted platform, offering 120kg capacity at an outreach of 11.25 metres. Also on display will be the 21 metre B210PXJ with articulating jib, mounted on a 3.5 tonne Mercedes Sprinter with 250kg platform capacity, 10 metres unrestricted outreach and 450 degrees slew. The jib is also available on the 22 metre B220TJ telescopic.



Haulotte UK: Stand 104

Haulotte will show a variety of boom and scissor lifts as well as its popular mast booms. The highlight will be models from the new five model

HS18E-Pro



Compact AE electric scissor range, which extends from eight to 14 metres offering extended battery life and lower maintenance costs. The 20ft Star 8S vertical mast type lift, is now equipped with the company's Activ'Energy Management battery system - which is well worth asking about. The Haulotte boom lift line up will be represented by the 46ft Sigma16 Pro electric articulated boom and the fully electric 53ft HS18E-Pro.

On the stand: Compact 10AE and Compact 10N AE, Star 6 Crawler, Star 8S and Star10AE, HS18E-Pro electric RT scissor, Sigma 16-Pro and HA20LE-Pro

Hinowa: Stand 500

See Access Platform Sales (APS)

Hird: Stand 303

Hird will show several models from the Oil & Steel truck mounted range, alongside some of new spider lifts including at least one of its new Octoplus models.

On the stand: Snake 2010 + H, Octoplus 17 Lithium





Close Brothers
Asset Finance

FLEXIBLE FINANCE TO SUPPORT YOUR BUSINESS

We provide tailor-made support, specialist industry knowledge and fast, firm lending decisions.

If you are looking to purchase new or used equipment, or release capital held in existing assets, contact our team.

 closeasset.co.uk/vertikal

Visit us
at stand
306

Close Brothers Asset Finance is a trading style of Close Brothers Limited. Close Brothers Limited is registered in England and Wales (Company Number 00195626) and its registered office is 10 Crown Place, London, EC2A 4FT.



Comet Eurosky
26|2|13 HQ JIB

Hydraulic Platform Services: Stand 408

Comet Platforms UK dealer Hydraulic Platform Services will show several van and truck mounted platforms from the manufacturer's range, including a 14 metre van mount, the 20 metre articulated Eurosky 20 | 2 | 10 HQ JIB and the 31 metre New Eurosky 31 | 2 | 17 HQ JIB - all making their UK debuts.

On the stand: 14 metre van mount, 20 and 31 metre articulated truck mounts

Imer: Stand 301

Imer will show three spider lifts on its stand. Smallest is the compact 15 metre IM R 15 DA with 230kg platform capacity and dual sigma type riser, two section telescopic boom and jib for an outreach of seven metres and a seven metre up & over height. Standard specification includes hydraulic adjustable track width and a choice of lithium battery or AC electric motor power. The 19 metre/230kg capacity IM R 19 SA EVO features a single riser, telescopic boom and jib and is also available with lithium and AC electric motor. The variable outrigger set up 23 metre IM R 23 DA, currently the largest spider lift in the Imer range, will also be on display.

On the stand: IM R 15 DA, IM R 19 SA EVO and IM R 23 DA



IM R 19 SA EVO



Easy Lift
R130

Independent Access Sales: Stand 209

Independent Access Sales - the distributor of Easy Lift aerial platforms in England - will show several tracked spider lifts including the 36 metre R360, the 24 metre articulated RA24, the 18 metre R180 and the 13 metre R130. The company will also be talking about some of the latest product support initiatives from replacement parts to full repair and service packages.

On the stand: Easy Lift R360, RA24, R180, R130

International Platforms: Stand 205

International Platforms specialises in buying and selling new and used platforms for an international customer base. It will highlight its 'as seen' or 'fully refurbished' products, as well as the finance options it can organise, on-site valuations and training. The company will have a number of used machines on display, which can be purchased at the show, including a fully refurbished 32ft Skyjack SJ6832RT and 19ft Skyjack SJ3219, as well as a Dingli 1612DC, Genie GS3246, JCB 2632E and a Manitou 160ATJ. The company also represents Metal & Modular low level platforms including the six metre Navigator 6.0 and the recently launched



Vicki Allen of
International Platforms

4.5 metre Navigator 4.5 - both fully mechanical push around scissors.

On the stand: Metal and Modular Navigator 6.0 and Navigator 4.5, Skyjack SJ3219, Skyjack SJ6832RT, Dingli JCPT1612DC, JCB S2632E, Manitou 160ATJ and Genie GS3246

IPAF: Stand 618

The International Powered Access Federation will have a substantial display of models from member companies that are exhibiting at the event, offering training demonstrations and highlighting the importance of promoting safe practices.

Isoli: Stand 504/505

See CPL

JCB: Stand 406/506

JCB will have a packed stand which will include its first fully electric telescopic handler - the 525-60E - offering zero on site emissions and significantly lower noise levels. If you have not already seen its 360 degree telehandlers, then this is your chance, it will show the 555-210R model, well worth a look. On the access side, the company will have several scissor lifts on display from its nine model range of slab electric scissor lifts with platform heights from 15ft to 45ft and platform capacities from 227kg to 550kg.

On the stand: S1530E, S4550E scissors, JCB 525-60E, JCB 555-210R and JCB Power Products



Discover
Innovative Battery Solutions

Creating innovative battery solutions that work in real world access & lifting applications.



VISIT US AT VERTIKAL DAYS
10th - 11th May 2023, Peterborough
STAND MP11

WWW.BBLBATTERIES.CO.UK 0808 1680635

JLG: Stand 310

JLG - back at Vertikal Days for the first time since the pandemic - is planning a very busy stand with a display of its low level 'Power Tower' platforms and electric scissors which includes the oil free DaVinci range. This is also an opportunity to meet the staff and learn about its new sales strategies.

On the stand: Eco WR, Peco, Nano, Nano SP, Power Tower ES1330, ES1530, R1932, R2632, R3246, R4045

Klass: Stand 515

See Kranlyft

Klubb: Stand 504/505

See CPL

Leguan Lifts: Stand 604

Finnish manufacturer Leguan Lifts will show its recently launched tracked spider lift, the 22.5 metre/250kg Leguan 225. Also on the stand will be its other tracked spider models including the 19 metre 190 and the interesting 13.5 metre 135 Neo - as well as the Avant Techno e6 mini wheeled loader and the Leguan 50, a five metre platform mounted directly onto Avant loaders quick attach plate.

On the stand: Leguan 225, Leguan 190, Leguan 135 Neo, Avant E6 mounted with Leguan 50



Leguan 190



LGMG: Stand 200/300

See Access Platform Sales (APS)

LiuGong Machinery Europe: Stand 501

Making its very first appearance at Vertikal Days, LiuGong will be showing a selection of its booms and scissor lifts including two diesel/battery electric slab scissors - the LSC1012DE and the LSC0607DE - as well as its 20 metre LA20JE articulated boom.

On the stand: LSC1012DE, LSC0607DE, LA20JE

Maber: Stand 603

See CLM Construction Supplies



Pick & Carry Cranes

 100% Electric



V210R

Max Lifting Capacity: 21000kg



Octopus 21

Max Working Height: 20.7m

Spider Booms



www.hirdsales.co.uk



Geda 200Z

Mace Industries: Stand 502

Mace Industries - the UK distributor for Geda hoists, passenger lifts and portable inclined lift/conveyors - will display a variety of hoists including a 21 metre/250kg Geda ladder hoist, the 200Z Geda rack and pinion goods hoist with a 200kg safe working load, the 850kg materials/500kg transport 500ZZP and the 1,500kg 1200ZZP transport platform. It will also be showing the Bumpa - an inclined lift which aids the loading of tiles onto a roof.

On the stand: Geda ladder hoist, 200Z, 500ZZP and 1200ZZP and Bumpa

Magni Telescopic Handlers: Stand 108

Italian telehandler manufacturer Magni will show machines from its wide range of fixed frame and



360 degree telehandlers with lift heights up to 51 metres and capacities up to 50 tonnes. For industrial applications the company now offers a specific product range with capacities from 4.5 to six tonnes. On the stand will be the six tonne/30 metre RTH 6.30 360 degree telehandler as well as a selection of attachments.

On the stand: RTH 6.30

Manitou: Stand 103

Manitou will show several models from its new range of all electric boom lifts, including the new 46ft 160 ATJe all-electric Rough Terrain boom lift, with beefed up lift structure and a fully galvanised platform. The new ULM 412 - Ultra Light Manitou - telehandler weighs 1.25 tonnes making for easy towing behind any 4x4 and has a maximum lift height of 4.3 metres and 1.5 tonne lift capacity. Manitou will also display its 3-in-1 MRT telehandler, winch and aerial work platform with a multitude of compatible attachments.

On the stand: ULM 412, 160 ATJe, 200 ATJe, 120AETJ, MRT telehandler

Mecaplus: Stand 404

See Alfa Access Services

Metal & Modular: Stand 205

See International Platforms

Multitel Pagliero: Stand 509

Multitel Pagliero will have four platforms on its stand - three 3.5 tonne truck mounts and a spider lift. The truck mounts will include its fully hydraulic 19.9 metre HX 200 EX with aluminium base frame and front/rear extendable stabilisers, plus a 25.1 metre MZ 250 mounted on a compact three metre wheelbase chassis with all functions managed by Multitel's MUSA system which optimises machine performance based on the load in the platform, slew position, and outrigger set up. The third unit is an MJE 250 with a working height of 24.7 metres and features a high strength



Multitel SMX 250

aluminium boom topped by a jib with 180 degrees of articulation. Finally, the 25 metre SMX 250.2 spider lift with variable position outrigger set up will round out the display.

On the stand: MJE 250, SMX 250.2, HX 200 EX, MZ 250, SMX 250.2

Niftylift: Stand 314

UK manufacturer Niftylift will show several models from its articulated boom lift line up. The highlight of its display will be the worldwide launch of its new 86ft HR28 Battery which offers a full 28 metres of working height. Other models will include three all-electric models, the 33ft HR12LE, the new 50ft HR17E and the 63ft HR21E. Completing the company's line-up will be its new spider lifts, including the 12.2 metre TD120TN Narrow and the low weight 50ft semi self-propelled SCD170.

All diesel models on show will have Euro Stage V compliant engines, or second generation Gen2 Hybrids. The company will also demonstrate its lithium battery power options for its all electric models.

On the stand: HeightRider12L All-Electric, HR17 All-Electric, HR21 All-Electric, Nifty 120T, TD120TN, SCD170, HeightRider28 Battery



Nifty 120T

Omega Solutions: Stand 404

See Alfa Access Services

Palfinger Platforms: Stand 504/505

See CPL

Pinnacle Platforms: Stand 507

See Sinoboom

Platform Basket: Stand 407

See Promax Access

SAEclimber's latest MCWP

NEW

The NEW P50/P50s

60ft (18,2m) length in single mast
and 5 tons (11,000 lbs) payload.



A package with onboard **GEN-SET** and **INVERTER** is also available to avoid any power connection and to have a very smooth and easy operation.

Several possible configurations
and accessories

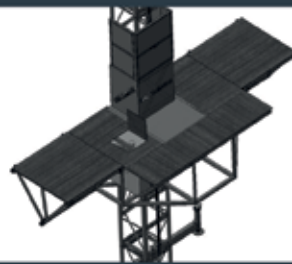
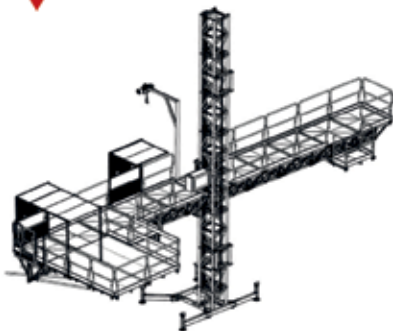

Self
propelled
chassis
also
available



Looking
forward
to meeting
you at the
**VERTIKAL
DAYS
SHOW**

Wednesday 10th
and Thursday 11th
May 2023
East of England
Showground,
Peterborough

Stand 201

66ft (20m)
Free standing
Height



Brick line
extensions



650x650
mast type



SAEclimber
mastclimbers
hoists



Platform Basket Spider 18.95 Hybrid

Promax Access: Stand 407

Platform Basket's UK distributor Promax Access will show several spider lifts including the 'telecoms' 33 metre Spider 33.15/300 and the 20 metre 'arborists' Spider 20.95 with fibreglass basket option. Pride of place will be taken by the 18 metre Spider 18.95 Hybrid which will make its UK debut. It offers a lower overall weight, an increased platform capacity of 230kg and full radio control operation. Hybrid versions are now available throughout the company's spider lift range, while onboard diagnostic displays are fitted as standard on every machine helping reduce downtime costs and delays.

On the stand: Spider 33.15/300 Hybrid, Spider 18.95 Hybrid, Spider 20.95 Hybrid and Spider 20.95 with GRP Cage

Raptor: Stand 204

See Socage

RAXTAR: Stand 305

RAXTAR offers a range of passenger and material hoists, transport platforms, common towers and software solutions for the high and midrise construction market. The company will launch several new products at the show including the RXS2300 transport platform/material hoist - the latest in the company's Smart Series - and the RXS2340 passenger and material hoist. The company will also demonstrate its new RX Control Next Level - a cloud based data solution aimed at eliminating downtime on site - while providing incident management and pro-active maintenance. The company's UK operation ANC Access runs a full service rental fleet of RAXTAR equipment.

On the stand: RX Control Next Level, RXS2300, RXS2340, RAXTAR Green Power Solution



Ruthmann: Stand 410/411/412

See Versalift UK

SAEclimber: Stand 201

Spanish mastclimber and hoist manufacturer SAEclimber will show several models from its range of construction hoists, transport platforms, goods only hoists and mastclimbers as well as customised solutions for demolition, cooling towers, nuclear plants, industrial facilities and permanent installations. The company prides itself on its in-house custom engineering team that can design, manufacture and even install bespoke solutions to almost any work at height or elevated transport application.



Sinoboom: Stand 507

Sinoboom will show a range of its electric boom and scissor lifts including the 40ft diesel 4069RD RT compact Rough Terrain scissor lift which features oscillating axles and outriggers as standard. Vertical Days will also host the UK launch of its new 53ft all-electric 5389RE Superdeck Rough Terrain scissor lift with twin deck extensions.



It will also have several electric Rough Terrain boom lifts on show with its 'Plus' models which offer platform capacities up to 455kg and feature standard non marking RT tyres. Another UK debut will be the 72ft AB22EJP articulated boom lift, the 15ft 1530SE micro scissor and 19ft 1932ME complete with a new AC direct drive alongside the 10 metre ML10EJ mast boom. The stand will be manned by the Sinoboom Team supported by its UK dealer Pinnacle Platforms and Irish dealer Lolex.

On the stand: TB20EJ Plus 4WD, AB22EJ Plus 4WD, ML10EJ, 1530SE, 1932ME AC Drive, 5389RE Superdeck, 4069RD Diesel RT

Skyjack: Stand 100

Skyjack will have a busy stand featuring the recently introduced 20ft SJ20E e-drive vertical mast lift with direct electric drive, its high capacity articulating booms and the X-Step option for scissor lifts. The SJ20E features fully proportional direct AC variable speed electric drive with up to 30 percent duty cycle improvement and smoother quieter controls with 70 percent fewer hydraulic connections. The traversing deck extends 410mm and with zero inside steering radius.

The lighter weight SJ45AJ+ and SJ60AJ+ offer platform capacities of up to 454kg and feature SmartTorque which optimises the gearing on the axle system along with a high efficiency hydraulics allowing the 25hp Kubota engine to deliver the necessary torque and performance found in larger engines.

On the stand: SJ20, SJ45AJ+, SJ60AJ+, X-Step





KEEP YOUR MEWP RUNNING SMOOTHLY WITH TVH.

- More than 1.5 million known references for MEWPs
- Parts suitable for all major brands
- Expert advice and extensive look-up services



High-quality replacement parts and accessories suitable for all major makes of MEWPs, including Aichi, Airo, Dingli, Genie, Grove, Haulotte, Hinowa, Holland Lift, JCB, JLG, Magni, Manitou, Niftylift, Skyjack, Terex, and more.

Vertical days

VISIT US ON STAND 510.

TVH PARTS NV

Brabantstraat 15 • 8790 Waregem • Belgium
T +32 56 43 42 11 • F +32 56 43 44 88 • info@tvh.com • www.tvh.com

KEEPS YOU GOING.

Snorkel UK: Stand 105/106

Snorkel will highlight several models from its extensive product range including the well proven and popular 12ft TM12 mast type lift, the S3010P and S3010E 10ft push around scissor lifts, the 19ft S3219E slab electric scissor lift and the 38ft electric articulated A38E boom lift.

On the stand: TM12, S3010P, S3010E, 3219E, A38E



Socage: Stand 204

Socage will show its latest 24 metre forSte24D Speed truck mounted platform with automatic outrigger set up, levelling and stowage. The feature is available on Speed truck mounted platforms up to 3.5 tonnes. Also on the stand will be the 14 metre forSte 14A pick-up mounted articulated platform on a 4x4 Ford Ranger chassis.

Vertikal Days will also host the European launch of the company's new Raptor brand which made its global debut at Conexpo. The line up has three models with 15, 18 and 21 metre working heights. The stand will feature the 18 metre 18S - definitely one not to miss.

On the stand: forSte 24D Speed, forSte 14A Pick Up, Socage Raptor 18S



STROS: Stand 402

First time exhibitor STROS - the Czech manufacturer of construction hoists and industrial elevators - will feature its NOV 2032 UP F4 passenger hoist with a maximum capacity of 2,000kg, a maximum speed of 45 metres a minute and a maximum build height of 350 metres. The internal dimensions of the cabin are 1.49 metres

by 3.1 metres and 2.4 metres with the option of installing two cabins per mast.

On the stand: Passenger hoist NOV 2032 UP F4

Teupen: Stand 404

See Alfa Access Services

Versalift UK: Stand 410/411/412

As the official UK distributor for Ruthmann and France Elévateur, Versalift will have a range of products on display including the new 23 metre Ruthmann TBR 230 Hybrid, 20 metre Ecoline RS200 and the new 26 metre Bluelift SA26 Hybrid spider lift.

From France Elévateur the company will show the 12 metre/120kg 121 Transit, capable of working with an outreach of up to seven metres without the need for outriggers or stabilisers.

As to Versalift products, you can find out just how easy it is to convert an existing Versalift diesel/PTO powered platform to full electric by watching live demonstrations of an E-Tech battery retrofit installation.

On the stand: France Elevateur 121 Transit, Bluelift SA26 Hybrid, Ruthmann TBR 230 Hybrid, Ruthmann Ecoline RS200

Workplatform: Stand 207/208

Genie's UK dealer Workplatform will show a range of boom lifts including the 60ft Genie Z-60 FE and 45ft Z-45 FE hybrid articulated boom lifts. The re-introduced Z-45/25J RT Rough Terrain diesel boom lift features a DPF-free engine for lower cost maintenance. The Genie scissor lift range



will be represented by the 32ft GS-3232, the 46ft GS-4655 and the 19ft GS-1932m Micro Scissor, featuring fully sealed, maintenance-free AC electric drive. A selection of Superlift Advantage (SLA) material lifts and AWP push around personnel lifts will also be on display.

On the stand: Genie Z-60 FE and Z-45 FE, GS-3232, GS-4655, GS-1932m, SLA and AWP lifts

XCMG: Stand 202/203

XCMG will have a stand full of machines making their world and European debuts. World debuts include the 43ft XG1523ERT electric RT scissor with a 15 metre working height and 700kg platform capacity and the 88ft all-electric XGS28ACK telescopic boom with a 28.8 metre working height and 460kg platform capacity. The upgraded 187ft XGS58E1 'Mega Boom' also makes its worldwide debut with a working height of 58.6 metres and working outreach of 24.8 metres.

A selection of scissor lifts and articulating booms will also be on the stand including the new 20ft XG0807AEW oil-free model.

On the stand: XG0608DC, XG0807AEW, XG1008AC, XG1012AC, XG1523ERT, XGA16E,



XGA20ACE, XGS28ACK, XGS58E1

Zoomlion: Stand 102

See AJ Access

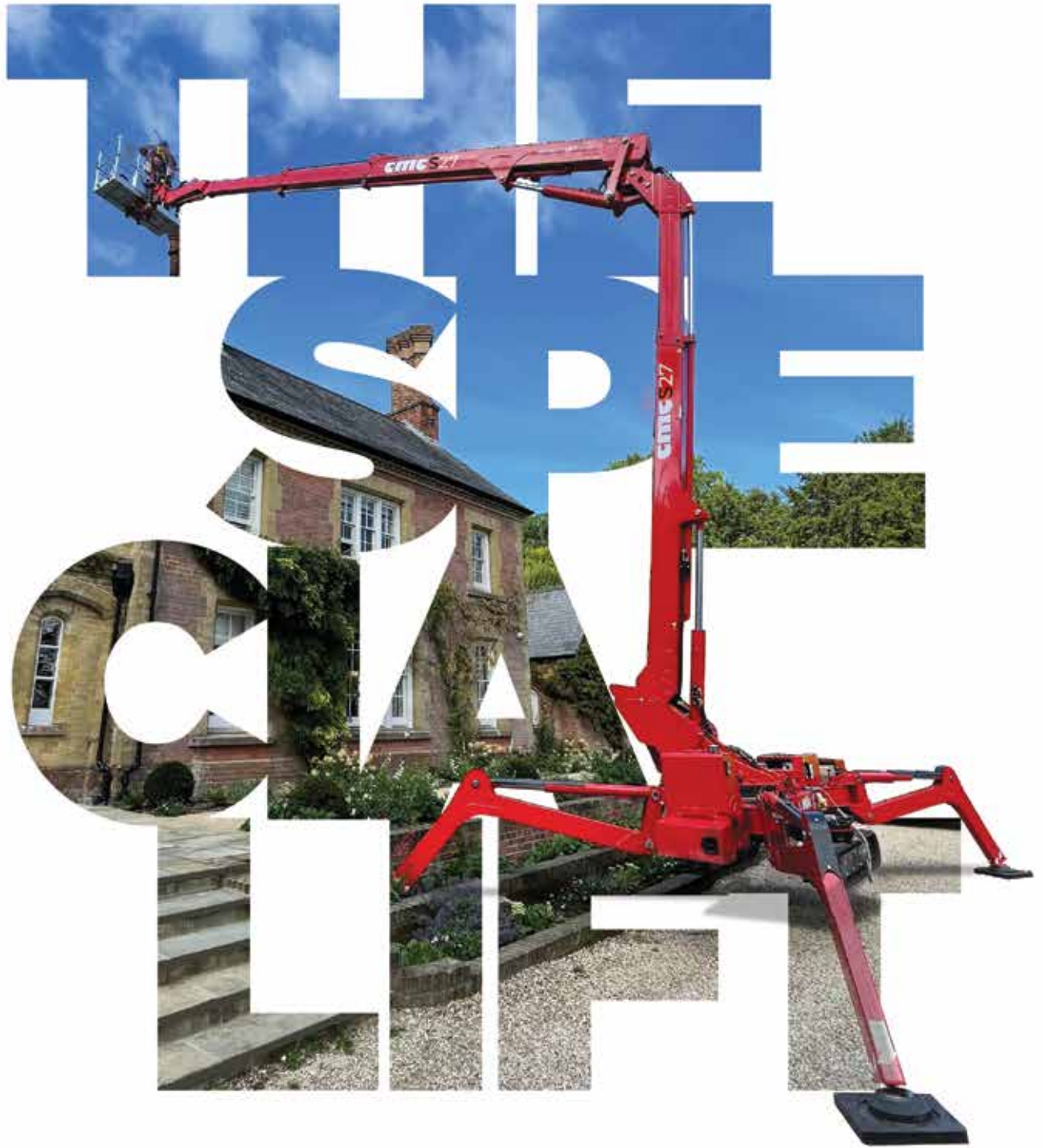

No matter your specialisation, you deserve our special attention.

The same dedication that we attribute to the manufacturing of our aerial platforms. No less than 14 models divided into six families, designed to respond perfectly to your requirements and your specific professional needs: **from tree care to the maintenance of buildings, installations and infrastructures; from restoration to work on high-voltage lines.**

Discover the advantages of the CMC range on our website.

CMC | **25**
THE SPECIALIST | YEARS

www.cmclift.com

CRANES

AlmaCrawler: Stand 503/206/308

Almac will show its T-Crane 1060 pick and carry mini crane which can be driven and used on slopes up to 22 degrees. Equipped with a standard remote control, the T-Crane 1060 can carry loads up to 990kg and has a 7.7 metre lifting height and 6.1 metre maximum radius.

On the stand: T-Crane 1060 pick and carry mini crane

Artic Crane: Stand 514

See City Lifting

BG Lift: Stand 206/308

See GGR Group

Böcker: Stand 107

Böcker will launch the new AK 48e truck crane to the UK market. The first fully electric steel/aluminium boom truck crane which is also available with a diesel PTO drive or as a 400V hybrid. The crane features improved working speeds and stability for high loads, a 180 degree luffing jib and tower crane function. Also on show will be the popular AK 46/6000 mounted on a three axle carrier and the AHK 36 trailer crane. The company will also be showcasing its hoist products including the trailer mounted Simply inclined lift and the Top-Lift ladder lift.

On the stand: AK48e steel/aluminium truck crane

City Lifting: Stand 514

The City Lifting team will be on hand to share its extensive knowledge and experience of all things crane related, both tower and mobile cranes. This year it will showcase its new crane guides which provide technical information on the full range of machines in its mobile and tower crane divisions. The company is also the UK distributor for Comansa and Artic Crane tower cranes.

Comansa: Stand 514

See City Lifting



LEOCH
LEOCH BATTERY UK LTD

GLOBAL PARTNER

We're Exhibiting at
Vertical days
Stand 307

Reduce downtime and increase your productivity!
For a **FREE TRIAL** of the LDC battery range don't hesitate to contact us

For enquires please contact **LEOCH BATTERY UK LTD.**
By phone on 01858 433 330, email us at sales.uk@leoch.com
or visit our website www.leochbattery.co.uk

NEW expanded DT range!

We have added new models to our most popular series for the industrial market to fit more applications

DT Lead Carbon AGM Technology

- Flooded Flat Plate technology
- True deep-cycle and deep-discharge capabilities
- More than 600 Cycles at 80% DoD
- Specially designed for maximum performance and durability
- Robust PP casing and handle for easy transportation and high vibration resistance

LDC Lead Carbon AGM Technology

- Fit & Forget - maintenance-free
- 1,000 cycles @60% DOD
- Wide operating temperature range
- Works with AGM charging profile
- Designed with high end safety features

Cormidi: Stand 206/308

See GGR Group

Crowland Cranes: Stand 112

Crowland Cranes represents the Grove Rough Terrain crane line and will partner with Manitowoc to display the new 100 tonne Grove GRT8100-1 Rough Terrain. Also on the stand will be Crowland's Power-Pad product range, along with two new products - the Power-Pad Mod Lite aluminium modular outrigger pad system and the Power-Blok plastic cribbing system.

On the stand: Grove GRT8100-1 RT, Power-Pad MOD Lite and Power-Blok plastic cribbing

Demag: Stand 114/115

See Tadano UK

Emerson Crane Hire: Stand 613

Emerson will debut two of its new Liebherr All Terrain cranes - the 450 tonne, eight axle LTM1450 8.1 which will be displayed alongside its brand new fully equipped escort vehicle and the 60 tonne, three axle LTM1060-3.1 which features the VarioBase variable outrigger set-up and monitoring.

On the stand: Liebherr LTM 1450-8.1 and LTM1060-3.1



Falcon Tower Crane Services: Stand 611

Falcon Tower Crane Services will focus on sustainability showcasing the newly released JCB Stage V generators, Punch Flybrid System and Northvolt Battery System - most definitely worth a look.

On the stand: JCB Stage V Generator PUNCH Flybrid System, Northvolt Battery System



MZ 250

**SOME JUST BUILD
TRUCK-MOUNTED PLATFORMS,
WE BUILD THE MZ 250.**

**The compact design, technology
and innovation of the Evolution range**

MULTITEL
SINCE 1911

WWW.MULTITELGROUP.COM

FB Gru: Stand 512

See Nationwide Group

Foster Cranes: Stand 508

UK crane sales and service company Foster Cranes will show several products from the Hoeflon range of cranes and transport carriers, including the 1.2 tonne TC1 Tracked Carrier and a TC1 mounted with a 550kg capacity crane as well as the fully electric, 3,000kg capacity C6e and the 4,000kg capacity C10 & C10e.

The company will also show the JMG MC100HY industrial pick & carry crane - JMG's first lithium powered hybrid crane - which features an onboard generator allowing users to run the crane indefinitely without the need for external recharging.

On the stand: TC1 tracked carrier, TC1 with crane and Hoeflon C6e, C10 and C10e

Galizia: Stand 206/308

See GGR Group

GGR Group: Stand 206/308

Specialist lifting equipment from the GGR Group will feature mini spider cranes, glazing robots and vacuum lifters. On display will be the new 17 metre Faresin full electric telehandler and the Almacrawler multi-loader range. GGR distributes UNIC, Sunward, Galizia, BG Lift, Almac and Glasboy as well as vacuum lifters and restricted access lifting machines.

On the stand: 17m Faresin all-electric telehandler and AlmaCrawler multi-loader



Glasboy: Stand 206/308

See GGR Group

Grove: Stand 110/111/112

See Manitowoc Cranes

Hird: Stand 303

Hird will exhibit two Valla remote controlled pick & carry cranes - the 11 tonne V110R and 21 tonne



Hoeflon C10e

V210R. Also on the stand will be the Spexlift Ergomover 1500 DC Electric Trolley.

On the stand: Valla V110R, Ergomover 1500 DC Electric Trolley

Hoeflon: Stand 508

See Foster Cranes

Jaso: Stand 611

See Falcon Tower Crane Services

Jekko: Stand 211/212

See JT Cranes

JMG: Stand 508

See Foster Cranes

JT Cranes: Stand 211/212

Jekko distributor JT Cranes will show a range of the Italian manufacturer's spider cranes including the latest SPX328, the SPX532, the SPX650



and the SPX1280. Also on the stand will be the heavy duty JF235 and JF545 articulated crawler cranes as well as the Jekko MPK 06 and MPK 50 minipickers pick & carry cranes. Accessories on show will include the Jib 500 GR Beam Clamp and Glass Manipulator JVM800

On the stand: Jekko SPX328, SPX532, SPX650, SPX1280, MPK 06 and MPK 50, Jib 500 GR Beam Clamp and Glass Manipulator JVM800

Klaas: Stand 515

See Kranlyft Group



Valla V110R

With Most Complete Variety Of Specifications

"AC" series: Lifting & Driving Dual AC



"HA" Series: Lifting AC



"PA" series: Oil-free & All-electric



Slab Scissor Lifts Series

ZHEJIANG DINGLI MACHINERY CO.,LTD.

ADD:188 Qihang Road, Leidian Town, Deqing, Zhejiang, P.R.C

TEL:+86-572-8681688

Phone:+86-13806523131 Susan Huang

E-Mail:export@cndingli.com

Https://en.cndingli.com



In recovery

ACCESS M20



Global TOP3

2021 Industry Global Manufacturers Sales Ranking

*Data source: Access International

Kranlyft Group: Stand 515

Kranlyft will concentrate on Maeda cranes showing the full battery electric crane range - the MC285CB-3 and MC305CB-3 - as well as the latest Maeda MK3053 knuckle boom crane. Also on show will be the smallest and largest CC mini crawler crane - the CC423 and CC1908 - as well as a Klaas aluminium boom truck crane.

On the stand: Maeda CC1908, CC423, MC305CB-3, MC285CB-3, MK3053 and Klaas truck crane



Liebherr : Stand 614/615/616/617

Liebherr will have an impressive display with several of the cranes on display making their UK debuts. It will also highlight its support services, such as operator training and instruction courses and planning software.

The UK debuts will include the 300 tonne LTM 1300-6.3 - the first six axle crane with 90 metres of main boom - and the five axle 110 tonne LTM 1110-5.2, the first to feature the Liccon 3 control system. The All Terrain line-up will also include

the 150 tonne LTM 1150-5.3, 230 tonne LTM 1230-5.1, 160 tonne LTM 1160-5.2 and 120 tonne LTM 1120-4.1.

The company's mobile self-erecting tower crane range will be represented by the MK88, alongside the regular 81k self-erecting tower crane and 100 tonne LTR 1100 telescopic crawler crane.

Liebherr's technical team will be demonstrating the latest updates to its Crane Planner software showing how to get full value from the

LTM1300-6.3





Come and see us on
STAND 215



alplift.com

Dutch excellence.

Alp Lift is leading the way in development and innovation of material lifting equipment. Check in on alplift.com and check out our extensive variety of manual and electric material lifts and air hoists, including some new designs.

Worldwide delivery from stock.



Supporting your performance at all heights.

'MyLiebherr' account, which allows access to all digital documents for the company's products. Liebherr Training Services will have a display and be available to advise on new technology and training courses.

On the stand: LTM 1300-6.3, LTM 1110-5.2, LTM 1150-5.3, LTM 1230-5.1, LTM 1160-5.2 and LTM 1120-4.1, MK88, 81k and LTR 1100

Maeda: Stand 515

See Kranlyft

Manitex Valla: Stand 303

See Hird

Manitowoc Cranes: Stand 110/111/112

The Manitowoc stand will include mobile cranes from Grove, alongside Potain tower cranes and will be promoting its customer support services including used crane sales, training, rebuilds and refurbishment, parts and repairs.

On the stand will be three All Terrains, one Rough Terrain and a tower crane. The Grove All Terrains include the five axle, 250 tonne GMK5250XL-1 with 78.5 metre main boom, the 120 tonne, five axle GMK5120L with 66 metre boom and the three axle 60 tonne GMK3060L-1.

The 100 tonne GRT8100-1 Rough Terrain is the upgraded version of the GRT8100 with a maximum tip height of 72.9 metres with the full swingaway extension installed. It also features a new chassis and engine along with variable outrigger set up. The Potain MR 229 is the company's first luffing jib tower crane with CCS control, it has a maximum capacity of 14 tonnes,

a 55 metre jib, two hoist winches, a 10.25 metre minimum out of service radius and Connect remote digital monitoring technology.

On the stand: Grove GMK5250XL-1, MR 229, GRT8100-1, GMK5120L, GMK3060L-1

National Crane: Stand 110/111/112

See Manitowoc Cranes

Nationwide Group: Stand 512

First time exhibitor at Vertikal Days, the stand will include all four Nationwide divisions: Nationwide Tower Cranes will have the UK's first FB Gru GA301 self-erecting tower crane on display, Nationwide Lifting Solutions will show the new Böcker truck crane, Nationwide Training Solutions will be on hand to discuss its new NPORS and CPCS training centre and Nationwide Plant Solutions will promote and discuss its site specific lift management services.

On the stand: FB Gru GA301 self-erecting tower crane



NMT Crane Hire: Stand 609

Crane hire company NMT will exhibit three of its latest cranes - the new 120 tonne four axle Liebherr LTM1120-4.1 with 66 metre main boom and 19 metre fly jib, the six axle Spierings AT6 eLift mobile tower crane featuring 100 percent electric use when on site and the 60 tonne three axle Liebherr LTM 1060-3.1 with 48 metre main boom. NMT will also be making some major announcements at the show as part of its relaunch programme.

On the stand: Liebherr LTM1120-4.1, Spierings AT6 eLift and Liebherr LTM1060-3.1



Bronto One

Increase uptime.
Minimize downtime.

Manage your business by data to gain better insights of your entire fleet and make the right decisions at the right time.



Get started today

The following list includes all exhibitors and the brands that they represent attending this year's event.



EXHIBITOR & BRAND LIST					
1Guava	607/608	Geda	502	performis	MP5
Aberdeen Web	MP18	GemOne	510 and MP30	Petzl	MP47
Access Platform Sales	200/300/400/500	Genie	207/208	Pewag	MP48
AJ Access Platforms	102	GGR Group	206/308	Pilotcar	404
Albright	510	Glasboy	206/308	Pinnacle Platforms	507
Alfa Access Services	404	Goman Lift	302B	Plant Planet	MP2
Alimak	601	Gorbel	MP15	Platform Basket	407
Alimats	217	Gouweleeuw	MP37	Platinum	MP24
Alliance Automotive Group	MP24	Grammar	510	PlumAlti	MP48
AlmaCrawler (cranes)	206/308	GRIPPS	MP47	Point of Rental Software	MP10
AlmaCrawler (access)	503	Grove	110/111/112	Potain	110/111/112
Almac	503	GS Yuasa	MP46	Power-Pads	112
Alp Lift	215	GSR	600	Promax Access	407
AMCS Technologies	MP13/14	Gunnebo Industries	MP48 and MP41	Pro-Spec	MP46
Ametek	510	Hammer	MP34	Pulmati	MP48
ANC Access	305	Haulotte UK	104	RAXTAR	305
APP	510	Hinowa	500	RaycoWylie Systems	MP33
ARESTA	MP47	Hird	303	Red Rooster	MP48
Artic Crane	514	Hitec Lift Trucks	113	Rent Pay Go	MP3
Autec	MP6	Hoeflon	508	ressys	MP5
Avant Tecno	604	Hoistech	405B	RHC Lifting	MP6
Avon	MP11	Hydraquip	405A	Righetti	303
Baldwin Filters	510	Hydraulic Platform Services	408	Roadside Technologies	MP28
Battery Service Hub	MP8	Hytorc Industrial Bolting Systems	MP31	Rolls	MP9
Bauser	510	Imer	301	Rotabroach	MP48
BBL Batteries	MP11	Independent Access Sales	209	RUD	MP48 and MP15
Beta	510	Inferno	MP32	Ruthmann	410/411/412
BG Lift	206/308	Infosystem	MP5	SAEclimber	201
Blokkam	MP41	InspHire	MP23	SafetyLiftinGear	MP34
Bluelift	410/411/412	International Platforms	205	Sany	214B
Böcker UK	107	IPAF	618	Sapphire	MP30
BoSS	400/500	Isoli	504/505	Scan Global Logistics	Entrance
Bravisol/Bravi Platforms	401	ITH Bolting Technology UK	513	Severn Sky Engineering	MP39
Brian James Trailers	403B	Jaso	611	Shield Batteries	MP46
Brilliant Ideas	217	JCB	406/506	Shuttlelift	110/111/112
Briggs	113	Jekko	211/212	Sinoboom	507
Brindley Chains	MP48	JLG	310	Skyjack	100
Bronto Skylift	606	JMG	508	SMIE UK	MP29
CAM attachments	510	JT Cranes	211/212	Snorkel UK	105/106
Capja	MP36	Kirkby Tyres	302A	Socage	204
Carl Stahl Evita	MP15	Kito	MP48	Spanset	MP48
Certex	MP12	Klaas	515	Spartan Solutions	MP20
City 1st Tyres	214A	Knipex	MP47	SPE Chargers	MP9
City Lifting	514	Kran & Bühne	Media Centre	Speedy Services	409
City Traffic Management Services	MP28	Kranlyft Group	515	Spexlift	303
CLM Construction Supplies	603	Klubb	504/505	Spierings Mobile Cranes	109
Close Brothers Asset Finance	306	Lasalign	216	SPT Spider Cranes	511
CMC	313	Latch and Batchelor	MP43	Stahl Crane Systems	MP48
Columbus McKinnon	MP48 and MP15	Leguan Lifts	604	Sterling Battery	MP46
Comansa	514	Leoch Battery	307	Straightpoint	MP48 and MP41
Comet UK	408	leva+	MP5	STROS	402
Cormidi	206/308	LGMG	200/300	Sunward	206/308
CPA	612	Liebherr Great Britain	614/615/616/617	TAB	MP9
CPL	504/505	LifeGear	MP34	Tadano UK	114/115
Cranes & Access	Media Centre	Lifting Equipment Engineers Association (LEEAA)	MP45	Tecnomagnete	MP15
Cranes Today	Marketplace	Lifting Gear Products	MP48	Tele Radio UK	MP40
Crosby	MP48 and MP41	Lifting Gear & Safety	MP12	Tensology	MP38
Crowland Cranes	112	Lifting Gear UK	MP12	Teupen	404
Crown Battery	MP46	Lift-Tex Heavy Lift Slings	MP32	The Crosby Group	MP41
CTE UK	101	LiuGong Machinery	501	Tiger Lifting	MP48
Curtis	510	Load Monitoring Systems	MP25	Top Service	MP17
DC Battery Technologies	MP21	Lolex	507	Torquer	MP16
delta-q	510	Lucas	MP9	Total Source	510
Demag	114/115	Maber	603	Towergate Insurance	MP19
Diepa	MP15	Mace Industries	502	Tracked Carriers	311
Dingli UK	602	Maeda	515	Trackunit	MP42
Dinolift	309	Magni Telescopic Handlers	108	Trojan Batteries	510 and MP21
Discover Battery	MP11	Manitex Valla	303	TurboPrecleaner	510
Donaldson	510	Manitou	103	TVH	510
Dynamic Load Monitoring	MP7	Manitowoc Cranes	110/111/112	TVH University	510
Dynaset	MP4	MCS Rental Software	MP35	UNIC	206/308
Dyneema	MP32	Mecaplus	404	Universal Crane Mats	210
Easy Lift	209	Metal & Modular	205	Uplifter	511
Ecobat Battery	MP9	Miller Weblift	MP15	UpRate Digital	MP22
Eichenger	MP48	Modulift UK	MP26	US Battery	MP8 and MP9
Electroelsa	605	Mouvers	403A	Valla	303
ELS Lift	404	Multitel Pagliero	509	Valvoline	MP24
Emerson Crane Hire	613	Myerscough College	MP1	Van Beest Green Pin	MP48
Energic Plus	510	My Future My Choice	Entrance	Verope	MP43
Enerpac	MP48	National Crane	110/111/112	Versalift United Kingdom	410/411/412
English Braids	MP48	Nationwide Group	512	Vertical Press / Vertical Days	Media Centre
Euro Auctions	MP44	Niftylift	314	Wienold	400/500
Extrema	MP32	NMT Crane Hire	609	William Hackett	MP48
Falcon Tower Crane Services	611	Niko	MP48	Winlet	303
Faresin	206/308	No Falls Foundation	618	Wippermann	510
FB Gru	512	Nolim	400/500	Wolffkran	607/608
Fleetguard	510	Oil & Steel	303	Wolff Onsite	607/608
Fluke	510	Omega Solutions	404	Woods Powr Grip	206/308
Foster Cranes	508	Onyx	MP30	Workplatform	207/208
France Elevateur	410/411/412	Outriggerpads	510	XCMG	202/203
Fronius	MP9	Palfinger Platforms	504/505	Xenith Heights	MP47
FT Wind Sensors	213A	Paragon Traffic Management	MP27	Xona	MP15
G-Force	MP34	PB Lift	404	Yoke	MP48
Galazia	206/308	Pegasus Battery	MP8	Zoomlion	102
Gantryd	405B				

Outdoor Site Plan

TVH
Show map sponsored by TVH

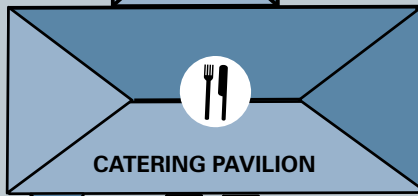

IPAF
618

BBQ Area

Star Shade

Vertical days

TADANO 114-115
HITEC/BRIGGS 113
MANITOWOC/ CROWLAND CRANES 112
MANITOWOC 110-111
SPIERINGS 109
MAGNI TELESCOPIC HANDLERS 108
BÖCKER UK 107

BRILLIANT IDEAS 217	NIFTYLIFT 314
LASALIGN 216	
ALP LIFT 215	
SANY 214B	CMC 313
CITY 1ST 214A	TRACKED CARRIERS 311
FT WIND SENSORS 213A	
JT CRANES 211-212	JLG UK 310
	DINOLIFT 309

VERSALIFT UK 410-412	KRANLYFT 515
	CITY LIFTING 514
	ITH BOLTING TECHNOLOGY 513
SPEEDY SERVICES 409	NATIONWIDE GROUP 512
	UPLIFTER 511
HYDRAULIC PLATFORM SERVICES/ COMET UK 408	TVH 510
PROMAX 407	

LIEBHERR 614-617
EMERSON CRANE HIRE 613
CPA 612
FALCON TOWER CRANE SERVICES 611
NMT CRANE HIRE 609
WOLFFKRAN 607-608

UNIVERSAL CRANE MATS 210	Marketplace MARKETPLACE JOB CAFE	MULTITEL PAGLIERO 509
INDEPENDENT ACCESS SALES 209		FOSTER CRANES 508
WONKRA PLATFORM/ GENIE 207-208		SINOBOOM 507

SNORKEL UK 105-106
HAULOTTE 104
MANITOU 103
AJ ACCESS PLATFORMS/ ZOOMLION 102
CTE UK 101
SKYJACK 100

GGR 206	308
INTERNATIONAL PLATFORMS 205	LEOCH BATTERY 307
SOCAGE 204	CLOSE BROS 306
	RAXTAR 305
XCMG 202-203	HIRD 303
	GOMAN LIFT 302B
	KIRKBY TYRES 302A
SAEclimber 201	IMER 301
LGMG 200	300

JCB 406	506
HOISTECH 405B	CPL 504-505
HYDRAQUIP 405A	
ALFA ACCESS SERVICES 404	ALMAC 503
BRIAN JAMES TRAILERS 403B	MACE INDUSTRIES 502
MOUVERS 403A	LIUGONG 501
STROS 402	
BRAVISOL 401	
APS HINOWA 400	500

BRONTO SKYLIFT 606
ELECTROELSA 605
LEGUAN 604
CLM CONSTRUCTION SUPPLIES 603
DINGLI UK 602
ALIMAK 601
GSR 600

KEY

- ACCESS
- CRANES
- TELEHANDLERS
- OTHER



Organisers
Office/Operations
Room



Entrance



My Future
My Choice

Visitor Parking



SUPRATEQ TW78

WHEN SIZE REALLY MATTERS!

4.3
inch



SEE US IN THE
MARKETPLACE
MP40

Our new SupraTEQ TW78 waistband transmitter, 33 centimetres wide, offering plenty of space for a vast number of controls to handle the most extensive tasks. Fully customisable for controlling complex hydraulic, mobile and industrial machinery. The SupraTEQ TW78 is robust and compatible with a wide range of BUS systems. For detailed graphical feedback you can rely on the large 4.3" colour display. Safety is included! The Stop function is independently certified and meets the SIL3, PLe+Cat3 standards.

Test Units and Demos Available! sales.uk@tele-radio.com



Now you have access to a choice!

U.S. Battery's Xtreme Capacity™ formulation with Diamond Plate Technology® yields the **highest initial capacity**, the **fastest cycle** up to rated capacity, and the **highest total energy** delivered over the life of the battery.

To buy your U.S. Battery,
call Battery Service Hub.

+44 (0)1858 433008

www.batteryservicehub.com

info@batteryservicehub.com



Visit Us On Stand MP8!

bsh
BATTERY SERVICE HUB
industrial energy solutions



ACCESS WITH ZOOMLION GREEN

VISIT US AT

Vertikal days 10 | 11
MAY
2023

PETERBOROUGH, UK |
STAND 102



Electrification
Sustainability



Zoomlion Intelligent Access Machinery Co., Ltd.
Add: 701 Kuzing Road, Xiangyang New District, Changsha, Hunan, China
E-mail: zaj@zoomlion.com Tel: +86-0731-88250971
Learn more at <http://www.zoomlion-access.com>



100% **MANITOU** 100% **ELECTRIC**

MRT E

The first electric rotating telehandler

Unchanged Performance

All the advantages and versatility of an MRT in an electric version. Ideal for work with environmental constraints, night work, or simply to reduce your emissions. For more information, please visit www.manitou.com

Visit Us At Vertical
Days!
Stand 103!

**REDUCE YOUR
EMISSIONS**

**RAISE YOUR
STANDARDS**



MANITOU
HANDLING YOUR WORLD

Potain: Stand 110/111/112

See Manitowoc Cranes

Righetti: Stand 303

See Hird

Sany: Stand 214B

Sany UK will exhibit the SCE600TB 60t telescopic crawler crane. With five section 46m main boom and boom synchronization feature via a twin telescopic cylinder and cables, the 9.2m to 16m bi-folding jib can be offset to 30 degrees. Powered by Cummins Stage V engine with a Rexroth hydraulic system.

Shuttlelift: Stand 110/111/112

See Manitowoc Cranes

Spierings Mobile Cranes: Stand 109

Dutch mobile self-erecting tower crane manufacturer Spierings will have two electric powered cranes on the stand, the SK1265-AT6 eLift and the SK487-AT3 eLift with eDrive. Both models can work completely emission free when on site.

On the stand: SK1265-AT6 eLift and SK487-AT3 eLift & eDrive



SPT Spider Cranes: Stand 511

See Uplifter

Sunward: Stand 206/308

See GGR Group

Tadano : Stand 114/115

Tadano will show two of its latest cranes: the 40 tonne two axle AC 2.040-1 - the first crane jointly developed by Tadano's Lauf and Demag Zweibrücken engineering teams - alongside the 80 tonne four axle AC 4.080-1. The AC 2.040-1 features the IC-1 Plus control system, the E-Pack for zero-emission crane operation, Surround View camera system and the Flex Base variable outrigger set up. It can travel with 1.1 tonnes of counterweight on board within 12 tonne axle loads. The fully extended 35.2 metre main boom has a capacity of 7.6 tonnes at a radius of eight metres.

Tadano claims the AC 4.080-1 blends 'outstanding

reach with exceptional versatility' and its lifting capacity in steep boom positions makes the AC 4.080-1 'unbeatable in its class'. In the UK it can travel fully equipped within 16.5 tonnes per axle or remain under 12 tonnes an axle with 9.3 tonnes of counterweight and swingaway extension, while 10 tonnes is possible with 3.3 tonnes of counterweight.

On the stand: AC 2.040-1, AC 4.080-1

Unic: Stand 206/308

See GGR Group

Uplifter: Stand 511

SPT spider crane distributor Uplifter will make its Vertikal Days debut this year showing a selection

of spider cranes, glasswork machines, tracked carriers and vacuum lifts, while promoting its rent programme which covers its entire product range. In the event of an emergency, Uplifter says it can supply the correct lifting equipment to any UK site within the shortest possible time.

On the stand: SPT299 and SPT499 spider cranes, Glassworker GW625 and GW1125, UPM1225 tracked carrier, UPG600 and UPG350 vacuum lifter

Valla: Stand 303

See Hird

Weinold: Stand 400/500

See Access Platform Sales

Winlet: Stand 303

See Hird

Wolffkran: Stand 607/608

This year Wolffkran will exhibit its Wolff 355 B luffing jib tower crane with a maximum capacity of 28 tonnes and 60 metre jib. It will also have one of its 250 tonne Grove All Terrain cranes on the stand. Wolff Onsite will present in-house lifting accessories including Big Red - cantilever cage - and the new Anti-climb camera system. It will also demonstrate its new online software package 1Guava to keep project lift plans on track. It can manage, allocate and track the utilisation of cranes as well as all the construction plant on site.

On the stand: Wolff 355 B, Grove 250 tonne AT, 1Guava software package



OTHER EQUIPMENT

1 Guava: Stand 607/608

See *Wolffkran*

Aberdeen Web: Stand MP18

Aberdeen Web - one of the UK's leading manufacturers of webbing slings, round slings and ratchet systems up to 250 tonnes - will have one of its new 250 tonne WLL round slings on display that has been full tested in its own inhouse test facilities.

On the stand: 250TE WLL round sling



Albright: Stand 510

See *TVH*

Alimats: Stand 217

See *Brilliant Ideas*

Alliance Automotive Group: Stand MP24

Platinum International will show products from its range of deep cycle flooded, carbon AGM and starter batteries. Its deep cycle range is fitted as standard equipment by several aerial lift manufacturers. The company prides itself on providing free delivery without a minimum order value, it will also collect waste batteries and oil through its partnership with Valvoline. Stop by the stand to enter a number of prize draws.

On the stand: Platinum deep cycle, AGM, automotive and commercial batteries, Valvoline oils

PLATINUM
INTERNATIONAL
an Alliance Automotive Group Company

AMCS Technologies: Stand MP13/14

French safety device manufacturer AMCS Technologies manufactures anti-collision and zoning products for tower and other cranes and will have two new additions to its product line on display - the DCS 61-S driving control safety system and the CAM 61 video camera.

The DCS 61-S automatically detects the movements of mobile cranes and integrates the information into the control of tower



cranes. It calculates in real time and in 3D the distances between part of the crane - including the cab position - and movement speed to enable a slowing down followed by a complete immobilisation of the tower crane at a pre-set distance from the mobile crane. The CAM 61 camera for cranes features high definition, a 36x optical zoom, 16x digital zoom, day/night vision ICR filter, autofocus and image stabiliser.

On the stand: CAM61 and DCS 61-S

Ametek: Stand 510

See *TVH*

APP: Stand 510

See *TVH*

ARESTA: Stand MP47

See *Xenith Heights*

Autec: Stand MP6

See *RHC Lifting*

ecobat

BATTERY

Any Battery. Anywhere.

Experts in batteries, chargers, inverters, solar and accessories.

Vertical days
Come and visit our stand! MP9

VISIT US AT ECOBATBATTERY.COM

Avon Batteries: Stand MP11

See BBL Batteries

Baldwin Filters: Stand 510

See TVH

Battery Service Hub: Stand MP8

Battery Service Hub will show a range of US Battery and Pegasus products. US Battery products will make their first appearance at Vertikal Days - they have been fitted as standard equipment by several aerial lift manufacturers for more than 30 years. Products on show will include AGM, Gel and lithium batteries and chargers.

On the stand: US Battery and Pegasus



Bauser: Stand 510

See TVH

BBL Batteries: Stand MP11

First time exhibitor BBL Batteries is another leading UK battery distributor. The company will use the event to launch its new exclusive sales and distribution partnership with Canada-based Discover Battery, a global manufacturer and developer of Motive Power batteries.

Products range from deep cycle Dry Cell AGM and Gel Cell lead acid batteries to Lithium battery solutions with integrated smart systems, fast charging and cold temperature capability. BBL will also display its Avon battery range.

On the stand: Dry Cell AGM, Gel Cell and Lithium Batteries, Battery Chargers



Beta: Stand 510

See TVH

Blokcama: Stand MP41

See The Crosby Group

Brian James Trailers: Stand 403B

Yet another first time Vertikal Days exhibitor is Northamptonshire based Brian James Trailers. The company will unveil its new 'General Plant' trailer at the show, with tilt bed and super grip



deck panels which it says is ideal for transporting aerial work platforms. Features include low long-term running costs, smooth and quiet towing and a five year chassis warranty. Its 'Connect' flatbed trailer will also be on the stand, fitted with the optional tilt bed and full width punched tail ramp. It is available with a vast range of bed sizes, colours and options, this is apparently the trailer of choice for many equipment dealers, rental companies and contractors. The company's detailed online configurator helps buyers build up the trailer, automatically calculating the load capacity and price.

On the stand: General Plant tilt bed trailer, Connect tilt bed trailer

DESIGNED FOR RENTAL

Skyjack's vertical mast lifts with direct AC electric drive offer a quiet and versatile package with zero emissions.

STAND 100



SJ20E
NOW AVAILABLE

SKYJACK
simply reliable

www.skyjack.com



OUTRIGGER PADS

Our Multi Mat System offers superior strength and durability for high capacity lifting with the flexibility to use in various configurations.



EASY TO TRANSPORT



FAST SET-UP TIME



EASY TO CONFIGURE



SCAN TO LEARN MORE

© TVH Parts NV, Brabantstraat 15, B-8790 Waregem. All rights reserved.



Brilliant Ideas: Stand 217

Brilliant Ideas will showcase its Alimats range of interlocking aluminium outrigger mats with sizes from 0.33 to 8.07 square metres and weighing between 13kg and 48kg making them easy for two people to handle. The highlight of the stand will be the brand new 'Half Loader Spreader Module' which will replace crane pads on the Alimats system. Designed to provide a more even load spread under high outrigger loadings, it complements the existing range of modules spreading the outrigger load over two locations. The new profile is deeper than the standard Alimats profile and three times stiffer.

On the stand: Half Load Spreader Module

Briggs: Stand 113

See *Hitech Lift Trucks*

Brindley Chains: Stand MP48

See *Lifting Gear Products*

CAM attachments: Stand 510

See *TVH*

Capja: Stand MP36

Capja specialises in digitising timesheets and check sheets with an easy-to-use app, tracking employee hours and job progress without manual paperwork. The company will feature its



CapjaDocs solution, which uses dynamic QR codes to store and access critical information related to physical assets or spaces. The portal allows the creation and management of secure QR codes that link to handbooks, LOLER certificates, specification sheets and PDI/PUWER, product videos etc, providing instant access to the information. The company is also introducing an asset manager for LOLER inspections. Using NFC/QR tags it allows the efficient addition of accessories into the tackle register.

On the stand: CapjaDocs, AssetCapja, Timesheet & Check sheet mobile app

Carl Stahl Evita: Stand MP15

Carl Stahl offers a wide range of standard lifting equipment as well as specific advice and bespoke designs for more unusual lifting requirements. The product range includes permanent lifting magnets, electromagnetic lifters, Diepa crane ropes, general purpose wire ropes, load balancers, crane systems, lifting points, lifting beams, plate clamps, grabs, electric chain hoists, chain blocks, digital load cells, hand winches, fork lift attachments and vacuum lifters.

On the stand: Tecnomagnete MaxX permanent lifting magnets, RUD lifting points, polyester webbing slings/roundslings



Certex: Stand MP12

See *Lifting Gear UK*

City 1st Tyres: Stand 214A

Making its debut, City 1st Tyres is the UK wholesaler for Dunlop and Goodride Crane Tyres and offers a national UK service network.



City Traffic Management Services: Stand MP28

First time at the show, City Traffic Management will showcase the latest technology in traffic management systems, making sites safer by removing the potential for incidents and accidents.



On the stand:

Traffic lights, Variable message signs

Close Brothers Asset Finance: Stand 306

Over the past 30 years Close Brothers Asset Finance has grown to become a leading finance company for businesses wanting to buy new or used equipment. Its team understands the industry and offers tailor made, practical solutions. Backed by Close Brothers merchant bank it can offer Hire Purchase, Lease and Refinance for small to medium size companies.



Columbus McKinnon: Stand MP15 and MP48

See *Carl Stahl Evita and Lifting Gear Products*

CPA: Stand 612

The CPA - Construction Plant-hire Association - the leading trade association for equipment rental in the UK, will have its team on hand to offer all manner of advice and guidance. It will also host one of its Mobile Crane and Tower Crane Interest Group meetings, where topics will include Drop Prevention and Engineered Solutions, Alternative Energy Solutions, Routing and Authorities, CAA CAP1096 Update and the CPA Guidance - Procurement of a Mobile Crane. Members wishing to attend this event should ideally register their interest with Rob Squires at rob@cpa.uk.net



Cranes Today: Marketplace

The oldest English language magazine will have the latest issues on display.

Cranes & Access: Media Centre

Cranes & Access magazine - part of the lifting equipment news provider Vertikal Press - is the leading publication for the crane and aerial lift industry, with each issue generating a readership in the region of 30,000 across more than 200 countries. The magazine includes features on equipment types, innovations and techniques as well as its regular columns and news.

See *Kran & Bühne, Vertikal.net, Vertikal Press*



Crosby: Stand MP41

See *The Crosby Group*

Crown Battery: Stand MP46

See *Shield Batteries*

Curtis: Stand 510

See *TVH*

DC Battery Technologies: Stand MP21

Now part of the Sunlight Group, DC Battery Technologies is the UK master distributor for Trojan Batteries and will display both existing and new batteries including the recently launched Trojan AES range. Technical experts from Trojan will be on the stand to help answer any questions.

On the stand: Trojan Lithium and Trojan AES



delta-q: Stand 510

See *TVH*

Diepa: Stand MP15

See *Carl Stahl Evita*



Kranlyft Group

Come see the new MAEDA MK3053 at Vertikal days



MK3053C

eco

STD

ECO

ECO





Max capacity 2,8 t x 1,8 m
 Max lifting height 16,95 m
 Max working radius 14,3 m
 Extendable tracks
 Main boom with 4 falls hook mode
 Battery or Diesel / Electric power

www.kranlyft.com | +44 117 982 6661 | info@kranlyft.co.uk

Discover Battery: Stand MP11

See *BBL Batteries*

Donaldson: Stand 510

See *TVH*

Dynamic Load Monitoring: Stand MP7

Dynamic Load Monitoring specialises in the design, manufacture, repair and calibration of load cells, load monitoring and cable working equipment for the offshore, renewable energy, marine, subsea and lifting and rigging industries. It will be showing its Telemetry Shackle Load Cell TS-3.0, Telemetry Tensile Link TL-3.0, Small Telemetry Compressive Load Cell TC-3.0-SM.

On the stand: Telemetry Shackle Load Cell TS-3.0, Telemetry Tensile Link TL-3.0, Small Telemetry Compressive Load Cell TC-3.0-SM,



Dynaset: Stand MP4

Hydraulic equipment manufacturer Dynaset specialises in converting the hydraulic power of



mobile machinery into electricity, high pressure water, compressed air, magnet power, vibration, vacuum and power boosting.

On the stand: Hydraulic generators, magnet generators and compressors, hydraulic high pressure water pumps

Dyneema: Stand MP32

See *Lift-Tex Heavy Lift Slings*

Ecobat Battery: Stand MP9

Eco Battery will have a wide selection of products including batteries, watering systems, solar panels, chargers, inverters and accessories from Rolls, US Battery, SPE Chargers, TAB, Fronius and Lucas.



Eichenger: Stand MP48

See *Lifting Gear Products*

Energic Plus: Stand 510

See *TVH*

Enerpac: Stand MP48

See *Lifting Gear Products*

English Braids: Stand MP48

See *Lifting Gear Products*

Euro Auctions: Stand MP44

Euro Auctions conducts unreserved auctions of industrial, construction and agricultural equipment on a global basis. It claims to sell more lots per auction than any other auction house. Visit the stand to find out more.



Extrema: Stand MP44

See *Lift-Tex Heavy Lift Slings*

Fleetguard: Stand 510

See *TVH*

Fluke: Stand 510

See *TVH*

Take Control of Your Documents

 Product Videos

 Handbooks

 PDI/POWER

 LOLER Certs

 Spec Sheets



Secure QR Codes You Control

www.Capja.co.uk

Fronius: Stand MP9

See Ecobat Battery

FT Wind Sensors: Stand 213A

First time exhibitor FT Technologies produces wind sensors for harsh conditions. With no moving parts or maintenance required they are said to provide consistent, reliable data for cranes and control systems. The technology is resistant to shock, vibration and the elements, making it ideal for use all year round. The sensors are widely used for wind turbine control and a range of industrial applications where wind data is critical.

On the stand: FT Ultrasonic Wind Sensor



Ganteryd: Stand 405B

See Hoistech

GemOne: Stand MP30

GemOne is a global provider of smart telematics solutions and will bring its Onyx fleet management solution for mixed industrial fleets to the show. The solution allows users to monitor their fleet in real time, including its location, when it is being operated and when it is due for maintenance. Also on the stand is Sapphire - a safety management solution for the material handling industry, as well as its Battery Monitoring Solution and 360 degree Proximity Warning System for forklifts.

On the stand: Sapphire, Onyx, Proximity Warning Solution, Battery Monitoring System



Gorbel: Stand MP15

See Carl Stahl Evita



Gouweleeuw: Stand MP37

First time exhibitor Gouweleeuw specialises in blasting and painting heavy equipment including aerial work platforms, cranes, telehandlers and earthmoving equipment. The company is happy to tackle any job, big or small and regularly works for manufacturers such as Liebherr, Tadano, Terex, Grove, Manitowoc, Spierings, Kobelco and GeesinkNorba. It operates three large facilities in Emmeloord, the Netherlands.

Grammar: Stand 510

See TVH

GRIPPS: Stand MP47

See Xenith Heights

GS Yuasa: Stand MP46

See Shield Batteries

Gunnebo Industries: Stand MP41 and MP48

See The Crosby Group and Lifting Gear Products

Hammer: Stand MP34

See SafetyLiftinGear

Unleash THE POWER of your HYDRAULICS!



No project too big or too heavy!

Gouweleeuw: The paint shop for vertical transport!



Short lead times



Safe and careful



More than 30 years of experience



Terex Demag TC 2800-1



Grove GMK 6300L-1

Specialized in painting:

- Mobile cranes
- Excavators
- Crawler cranes
- Aerial platforms
- Tower cranes
- Other heavy equipment

We work daily on assignments for leading manufacturers such as:

- Tadano
- Manitowoc
- Liebherr
- Kobelco
- Sany
- Spierings

But of course we also work for importers, dealers and end users (both new and used equipment) such as:

- Global Crane Services
- Osprey Marine Ltd.
- Allelys Installations Ltd.
- G. O'Brien Crane Hire Ltd.
- DM Cranes Ltd.
- Kavanagh Crane Hire Ltd.

Transport service:

If desired, we can take care of transport of the crane. We arrange international transport as well as transport from the port.

Would you like to know more about our transport service? Please contact us to discuss the options.



Phone number
+31 (0) 527 252 307
+31 (0) 6128 436 37



Email address
info@gouweleeuw.com



Visiting address
Ondernemersweg 14
8304 BH Emmeloord



Hitec Lift Trucks: Stand 113

Hitec Lift Trucks provides material handling solutions with a choice of new, used and rental equipment from leading brands including Hyster, JCB, Genie and Combilift. The company is also the official supplier of forklift trucks to Vertikal Days.

Hoistech: Stand 405B

First time exhibitor chain and rope supplier Hoistech is one of the longest running companies in the industry having served the Irish market for more than 40 years. The Dublin based company will exhibit Ganteryd lifting gear.

On the stand: Ganteryd lifting gear



Hydraquip: Stand 405A

Hydraquip claims to be the largest hydraulic hose replacement company in the UK. A first time exhibitor at Vertikal Days its stand will feature one of its brand new onsite hose replacement vans - part of a £2 million investment for 2023 to expand its fleet of 150 Mercedes-Benz Sprinters.

The company will also demonstrate its Job



Manager software which, it says, gives the customer total control of online requests allowing them to book and track hydraulic hose replacements and service jobs nationwide.

On the stand: On-site hose replacement van

Hytorc Bolting Systems: Stand MP31

Hytorc offers a full line of hydraulic, pneumatic and electric torque and tension tools for industrial bolting, as well as hire, sales, training, service and calibration of torque tooling worldwide. On the stand will be its 36 volt Lithium Series II Ultra Low Vibration Torque Gun, 18v Lion Gun, Hytorc Connect App, the MXT Plus Hydraulic Torque Wrench and Anti-Loosening, reaction-arm free J Washer.



Inferno: Stand MP32

See Lift-TEX Heavy Lift Slings

Infosystem: Stand MP5

Infosystem is a software company with more than 50 years' experience in Switzerland and Germany.



A first time exhibitor at the show its brands include leva+, performis and ressys. It also has a laboratory dedicated to individual development. The leva+ smart software solution for rental is new to the UK, it is both modular and expandable, developed with industry experts and customers including German, Swiss and Austrian crane and aerial lift rental companies Prangl, Wiesbauer, Toggenburger, UP AG and Rent-it.

On the stand: leva+

inspHire: Stand MP23

With more than 20,000 daily users worldwide, inspHire develops software for the aerial lift and lifting equipment rental sector. The company has a suite of additional applications including extra-secure Cloud Hosting and inspHire Mobile - a powerful mobile app that replaces manual processes and paper forms. inspHire will also introduce its brand new eCommerce solution WebPro, enabling customers to operate a 24/7 hire desk.

On the stand: Cloud Hosting, inspHire Mobile, eCommerce and WebPro



IPAF: Stand 618



IPAF will celebrate its 40th anniversary on its stand, while promoting its safety campaign around the loading and unloading of work platforms. Its staff will be on hand to answer any questions regarding safe work at height, including training and technical guidance.

ITH Bolting Technology UK: Stand 513

ITH Bolting Technology, another Vertikal Days first timer, is a leading supplier of tension and torque tools for tightening and loosening bolted joints bigger than M16 (2/8"). It operates through a worldwide distribution network including 12 wholly owned subsidiaries and more than 40 locations. The company's products include bolting tools - bolt tensioning cylinders, hydraulic torque wrenches, and electric battery-driven and pneumatic nut runners - fasteners, engineering solutions and service. A highlight to look for is the company's 'Stretch method' hydraulic torsion and friction free tensioning. Introduced in 1980 it achieves easily consistent pre-tensioning forces within a tolerance of ±2.5 percent and is one of the main methods to tighten or loosen bolted joints on slew bearings and turbines.

Kito: Stand MP48

See Lifting Gear Products

Kirkby Tyres: Stand 302A

Kirkby Tyres - the UK & Ireland's largest distributor of industrial, truck, OTR and agricultural tyres & wheels - is the exclusive UK distributor of BKT high-speed crane, OTR, port and various industrial/speciality tyres. Headquartered in Liverpool and Dublin, the company exclusively distributes Double Coin, Dynamax, Sailun and MRL brands to the UK and Ireland replacement markets. Its speciality is bespoke tyre and wheel assemblies to OEM specification.

Knipex: Stand MP47

See Xenith Heights

Kran & Bühne: Media Centre

Kran & Bühne is the leading German language magazine covering cranes, telehandlers and aerial lifts. The magazine includes features on major new equipment and techniques, as well as regular columns and news.

See Cranes & Access, Vertikal.net, Vertikal Press

Lasalign: Stand 216

Lasalign specialises in mobile wheel alignment and stresses the fact that correct wheel alignment ensures optimum fuel efficiency, while also reducing tyre wear - something often overlooked in the crane and access market. Pop onto the stand to find out more.



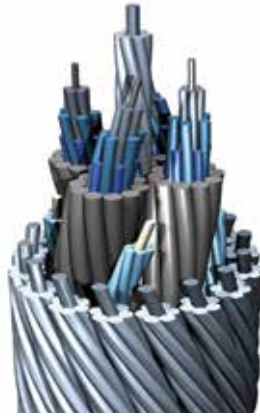

Latch and Batchelor: Stand MP43

Latch and Batchelor - a division of Webster and Horsfall - is the UK and Ireland supplier for Verope which manufactures premium wire ropes for all types of cranes and piling rigs. It also supplies wire rope assemblies to manufacturers such as Liebherr, Tadano, Demag, Terex and Grove with replacement end terminations installed on site if required.

On the stand: Veropro 8, Veropower 8 and Verotop E

Leoch Battery UK: Stand 307

Leoch Battery UK offers a wide range of battery technology options through its Leoch Battery and Power Saving Solutions division. The stand highlight will be the UK launch of the expanded DT series along with the LDC range developed by Leoch Battery, featuring a long service life and ability to perform at PSoC. Lithium options will also be on show, offering the highest depth of discharge and a longer design life.

On the stand: DT range



leva+: Stand MP5

See Infosystem

LifeGear: Stand MP34

See SafetyLiftinGear

Lifting Equipment Engineers Association (LEEA): Stand MP45

With more than 1,100 member companies worldwide, LEEA (Lifting Equipment Engineers Association) is the leading representative for the lifting industry. Established in 1944, the association provides a full range of training and accreditation services as well as access to expert technical advice, technical publications, networking



and marketing opportunities. Visit the stand to find out how to become a member. LEEA is also responsible for the Advanced Programme qualifications for the test and examination of lifting equipment. The Association issues 'TEAM' identification cards to employees of member companies that have passed these exams.

Lifting Gear Products: Stand MP48

Lifting Gear Products designs, manufactures, repairs and supplies lifting and mechanical handling equipment. The stand will feature PlumAlti, UK manufactured webbing slings, round slings, ratchet lashings and protective coverings alongside the G80, G100, G120 Chain Sling Systems, Dyneema round slings and associated Dyneema products, 2D and 3D CAD design capabilities and BSEN 1090 Execution Class 3 Fabrication.

On the stand: Shackles, cutters, mag drills, Dyneema products, ratchet lashings, chain slings, protective sleeving & coatings, round and webbing slings, fabrication & welding capabilities, lifting points



Lifting Gear & Safety: MP12

Sales, hire and inspection of lifting, height safety and marine safety equipment.

Lifting Gear UK: Stand MP12

Certex UK - sister company to Lifting Gear UK - offers Non-Destructive Testing of wire ropes using Magnetic Rope Testing (MRT) devices, while Lifting Gear UK supplies service and technical support.

On the stand: MRT head-Rope 22

Lift-Tex Heavy Lift Slings: Stand MP32

Extreema is the leading brand of Dutch fibre sling manufacturer Lift Tex Industrie. The heavy lift Extreema and HMPE slings are already widely used in offshore oil and gas projects. The new Inferno round sling will make its debut at this year's Vertikal Days. The ultra-heat resistant Inferno soft sling makes it possible to lift heavy payloads when working under extreme heat conditions - up to 200 degrees Celsius.

On the stand: Inferno heat resistant soft sling



Load Monitoring Systems: Stand MP25

Load Monitoring Systems specialises in the design, manufacture, sales and rental of lifting and load measuring products used in the marine, subsea, oil and gas, construction, mining and energy sectors. It will exhibit Load Links, Load Pin Shackles and other specialist lifting equipment as well as the new Digital Pad Eye Tester which features an onboard 'digital display', wireless and Bluetooth connections and adjustable clevis height and digital mounted display. Models are available with up to 30 tonnes proof test capability.

On the stand: Digital Pad Eye Tester, Load Link, Load Pin Shackle

Lucas: Stand MP9

See Ecobat Battery

MCS Rental Software: Stand MP35

MCS Rental Software will celebrate 40 years in the rental industry at Vertikal Days, with a stand that showcases its technological innovations in rental over the years, along with its latest additions including Transport Mobile updates and what3words integrations. Products introduced to the crane and access industries over the years range from resource planning to help organise and schedule resources, to the Timesheet Mobile app, simplifying and digitising the process of operators submitting hours completed for sign-off.



Miller Weblift: Stand MP15

See Carl Stahl Evita

Modulift: Stand MP26

Modulift designs and manufactures 'below the hook' lifting equipment including modular spreader beams, lifting beams and spreader frames. A new product on the stand is the Multi-Point Beam which has the option of a swivel hook and the ability to be used as a semi-spreader, lifting beam or for tandem lifts offering more





VISIT ALIMAK AT VERTIKAL DAYS 2023 – STAND #601

INTRODUCING THE ALL-NEW ALIMAK SCANDO 650a

Alimak is proud to present a new construction hoist that sets a new standard in the construction industry. We listened and have advanced the development of today's construction hoist. The all-new Alimak Scando 650a will drive productivity and enhance safety on construction sites. It's also one of the most sustainable hoists available.

Thanks to an innovative design, the new Scando 650a is 33% lighter, has a reduced environmental impact, and uses less electricity than its predecessor. The construction hoist connects with My Alimak – our customised web-based portal that provides vital performance insights to enhance productivity and safety at your construction project. The future of digitalisation has arrived.

Visit our website to explore the new hoist in virtual reality.

alimak.com

ALIMAK

flexibility than a standard beam. Next day delivery options are available and spreader beams come with DNV Type Approval as standard up to 2,000 tonnes. The company also offers a full engineering design service with 3D Design and FEA Analysis.

On the stand: Multi-Point Beam, Spreader beam, CMOD spreader frame

Mouvers: Stand 403A

Italian company Mouvers specialises in the manufacturer of radio remote controlled modular machinery skates for moving heavy loads. On the stand will be the Apollo 3.0 - a heavy duty, remote controlled skate for loads of up to 75 tonnes. It can be set-up in three or four support points and with powered steering rear rollers. Load height is just 150mm.

On the stand: Apollo 3.0



Myerscough College: Stand MP1

Myerscough College has been providing training for more than 125 years delivering a wide range of education programmes from Level 1 to post graduate level including Land based Service Engineering: Grounds Care/Construction/ Agriculture Level 2 and 3; Railway Engineering Technician Level 3; Team Leading Level 3 and Operations Management Level 5. The college works with a large number of employers within the construction, rental, lifting and railway sectors across the country with many apprentices attending on a block release basis. It can also provide advice on any education, training or apprenticeship requirements.



My Future My Choice: Entrance

My Future My Choice is all about working with engineers of the future. School students visit Vertikal Days and work with My Future My Choice and Liebherr apprentices to find out more about what being an engineer in the lifting and aerial lift industry is all about and discovering the opportunities it can provide.



Niko: Stand MP48

See Lifting Gear Products

No Falls Foundation: Stand 618

Every year hundreds of thousands of people work at height in a variety of industry sectors. What they all have in common is risk. The risk of a fall that might kill them or leave them with serious life-changing injuries with potentially devastating consequences for their families, friends and work colleagues.

The No Falls Foundation, in partnership with partners such as the AIF - Access Industry Forum - trade associations and professional bodies is committed to advancing health and safety, has three distinct objectives:

- To help keep people safe by creating greater awareness and understanding of the risks associated with working at height
- To better understand the causes of falls from height through research and the exchange of information and knowledge
- To support those people facing the aftermath and consequences of a fall from height.

Nolim: Stand 400/500

See Access Platform Sales (APS)

Outriggerpads: Stand 510

See TVH



Paragon Traffic Management: Stand MP27

Paragon Traffic Management specialises in traffic management solutions across a wide variety of industries. The company also provides tailored services for working at height with cranes and access platforms covering planning, design, execution and maintenance. It has an in-house license & permits division to minimise risks and disruptions. Services include traffic control, road closures, permit acquisitions and safety equipment provision.



Pegasus Battery: Stand MP8

See Battery Service Hub

performis: Stand MP5

See InfoSystem

Petzl: Stand MP47

See Xenith Heights

Pewag: Stand MP48

See Lifting Gear Products

Pilotcar: Stand 404

See Alfa Access Services

Plant Planet: Stand MP2

Plant Planet brings the latest construction plant news, machinery releases and insights from the heavy machinery industry to one place.

The magazine is issued bi-monthly and covers a variety of news across the construction plant industry in both digital and print formats.



Platinum: Stand MP24

See Alliance Automotive Group

Point of Rental Software: Stand MP10

Point of Rental Software provides rental and inventory management software solutions for every job role within a business. The company has introduced key features to the rental software industry for more than 40 years, from dispatching to wireless alerts to telematics integrations. The company serves customers in 80 different countries from offices in the USA, UK, Australia, South Africa and Canada.



Power-Pads: Stand 112

See Crowland Cranes

Pro-Spec: Stand MP46

See Shield Batteries

PlumAlti: Stand MP48

See Lifting Gear Products

RaycoWylie Systems: Stand MP33

RaycoWylie will use Vertikal Days for the UK launch of the i5000 series. The i5000 has more options than previous models, as well as new, simple to use controls, a high resolution touch screen display, newly designed graphics, updated user interface, increased compatibility and functionality. Also on display will be the i4500 crane monitoring system suitable for all types of cranes, the i4300 retrofit crane monitoring system ideal to replace an old or failing crane monitoring system and the i4000 wired and wireless wind speed monitoring system.

On the stand: i5000 Series



Reinvent your rental business through a complete digital transformation



Don't get left behind...

**Enjoy a brighter future
with inspHire**



See the inspHire team at Vertikal Days at Stand MP23 who will be showcasing fast, flexible and future-proof rental software solutions!

www.insphire.com | sales@insphire.com



Connecting Construction

Trackunit is the leading operating platform connecting people, machines and processes in construction to eliminate downtime.

Visit us during Vertical Days at booth MP42

AKSV1563218542300
 Working - 100% safe + Online
 Alarm Threshold
 Alarm Fuel Level 20%

Good
 Working

T0238782
 L3000r - 80000hr - T240H

Book a demo
trackunit.com



Intelligent Lifting Equipment

Contact us for a quote today
+44(0)1224 446100
lms@loadmonitoringsystems.com

Design - Manufacture - Hire - Repair

www.LoadMonitoringSystems.com

LEMA MEMBER
 GJH MEMBER
 DECOM North Sea
 EX
 ILEC

EURO AUCTIONS

We're exhibiting at Vertical Days - Stand MP44

We are the market leader in Europe; holding more sales and selling more lots per sale than any other auction house.

Come and speak to one of our highly experienced Territory Managers to see how we can help you with all your equipment needs!



www.euroauctions.com

Red Rooster: Stand MP48

See *Lifting Gear Products*

Rent Pay Go: Stand MP3

Another first timer, Rent Pay Go is an innovative software solution provider for rental companies to rent products 'Online' directly to customers and re-rental partners. The company says that it helps rental companies provide improved customer service, while maximising utilisation and boosting revenues.



ressys: Stand MP5

See *InfoSystem*

RHC Lifting: Stand MP6

RHC Lifting - the overhead gantry crane specialists and UK distributor for Autec industrial radio remote controls (now known as Cableless Control Systems, CCS) - will display Autec's range of industrial customisable controls systems designed specifically for spider lifts, lifting machines and telehandlers, as well as solutions for other hydraulic and mobile applications. Product solutions on display will include the Dynamic+P series, the new M-PRO and R-PRO models and the portable stations Compact, Link & Curve. You can also see the Lift series, the Air series which includes the AJT model, the R-PRO and the SK8B.

On the stand: M-PRO, R-PRO, SK8B



Righetti: Stand 303

See *Hird*

Road Side Technologies: Stand MP28

See *City Traffic Management Services*

Rolls: Stand MP9

See *Ecobat Battery*

Rotabroach: Stand MP48

See *Lifting Gear Products*

RUD: Stands MP15 and MP48

See *Carl Stahl Evita and Lifting Gear Products*

SafetyLiftinGear: Stand MP34

SafetyLiftinGear is a leading supplier of lifting equipment, materials handling, load restraint, height safety and confined space products. It will unveil several UK debuts including a LifeGear harness and lanyard and the Hammer material lift.

On the stand: LifeGear Harness, LifeGear Lanyard, Hammer material lift



Scan Global Logistics: Entrance

Experts in managing global events logistics.

Severn Sky Engineering: Stand MP39

Making its Vertical Days debut, Severn Sky Engineering is a specialist vertical access company which provides skilled engineers, including those dedicated to installation work for the rack & pinion lift and hoist industry. Call in to the stand to have a chat with operations manager Nicky Canfield and managing director Steven Webb who will answer all of your questions.



Shield Batteries: Stand MP46

UK battery distributor Shield Batteries offers a wide range of batteries for powered access, lifting equipment and telehandlers, while also providing fleet owners with an easy-to-use battery replacement service. Shield will have a wide range of batteries for aerial work platforms on show, including products from Crown, GS Yuasa Pro-Spec and Sterling.

On the stand: Crown CR220, CR390, Sterling HPC225-6, GS Yuasa



SMIE UK: Stand MP29

SMIE is a pioneer and leading manufacturer of zoning, anti-collision and site management solutions for tower cranes. Its products now have 4G connectivity for remote monitoring, reporting and programming.

On the stand: ProSite with 4G



Spanset: Stand MP48

See *Lifting Gear Products*

Spartan Solutions: Stand MP20

Spartan Solutions will use the event for the worldwide launch of the new Phalanx V6, a flexible software platform that digitises rental logistics and servicing processes. V6 delivers a range of integrated mobile apps to support the picking, packing, delivery, return, inspection



and servicing of rental equipment. The new form editor allows equipment experts to quickly design and deploy data forms to capture meter readings, checklist answers, equipment images, signatures and more. The V6 AI engine can also build and automatically run expert rules on equipment telematics data to deliver valuable services for customers demanding ultra-high availability. The V6 Hire Control portal includes the Operations Dashboard which tracks the real time health of an operation, monitoring equipment demand versus availability, logistics backlogs and damaged equipment.

On the stand: Phalanx V6

SPE Chargers: Stand MP9

See *Ecobat Battery*

Speedy Services: Stand 409

Speedy is one of the UK's leading equipment and tool rental businesses including access, lifting and hoisting rental solutions across the UK and Ireland.



Spexlift: Stand 303

See *Hird*

Stahl Crane Systems: Stand MP48

See *Lifting Gear Products*

Sterling Battery: Stand MP46

See *Shield Batteries*

Straightpoint: Stand MP41

See *The Crosby Group*

TAB: Stand MP9

See *Ecobat Battery*

Tecnomagnete: Stand MP15

See *Carl Stahl Evita*

Tele Radio UK: Stand MP40

Tele Radio specialises in the design and manufacture of customisable radio remote control solutions for the lifting, aerial lift and mobile equipment markets. The company will exhibit a range of products from simple pushbutton controllers to complex, customisable, proportional hydraulics and camera feedback systems designed for typical crane, hoist and mobile applications. Visitors will get an insight into how Tele Radio industrial remote controls are designed to improve efficiency and safety in the lifting industry.

On the stand: Suprateq TW78, Tiger G2





BRIAN JAMES TRAILERS

READY FOR WORK

Brian James Trailers have a number of solutions for the transport of lifts and access platforms, including the General Plant and Connect. Options include tilt bed and winches and all our trailers come with a **5 year chassis warranty**.



Visit us on Stand **403B** and at www.brianjamestrailers.co.uk

Tensology: Stand MP38

Tensology provides a full range of products, equipment and services for the installation, testing, inspection and lubrication of all types of crane rope. It also offers rope examinations using the latest Magnetic Rope Testing (MRT) equipment.

The company is an LEAA Accredited Training Company, providing specialist wire rope related courses such as the Tensology Crane Rope Examiners course. Delivered by crane rope expert David Hewitt, it is based upon the requirements of BS ISO 4309:2017 and provides essential theoretical knowledge and practical tips for anyone involved in the inspection or examination of wire ropes.



On the stand: Magnetic Rope Testing with real-time-viewing

The Crosby Group: Stand MP41

The Crosby Group is a leading manufacturer of rigging, lifting and material handling hardware with a network of more than 3,000 authorised distributors. The company will show a range of hi-tech solutions from group companies, including the new Blockcam M3L Crane Camera system and Straightpoint load monitoring equipment along with traditional rigging, lifting and material handling equipment.

Tiger Lifting: Stand MP48

See *Lifting Gear Products*

Top Service: Stand MP17



Top Service provides credit management solutions for the UK construction industry, specialising in credit information and debt recovery services to minimise exposure to bad debt and increase cash flow and business growth.

Torquer: Stand MP16

Torquer will show its hands free lifting and orientation devices for safe load handling. Its HALO system uses spinning water inside a circular shaped tank which generates torque to turn the connected load. The radio remote controlled thruster inside ensures no one needs to be near the load during lifting and positioning operations. Its 100 percent purely mechanical 'Spear' lifting product provides automatic connection and disconnection to a load. The company is also developing a radio controlled lifting device which will provide automatic connection/disconnection to pad eyes.

On the stand: HALO and SPEAR

Total Source: Stand 510

See *TVH*

Towergate Insurance: Stand MP19



Towergate Insurance will promote its range of services and hands on approach to protecting assets and supporting claims management. The company has more than 25 years experience in crane and equipment insurance and is a CPA registered provider.

Tracked Carriers: Stand 311

Tracked Carriers' growing range of material moving products will be on display - all designed and manufactured in Essex, UK. The company hopes to have at least one new product on the stand. Its latest tracked material carriers include direct AC drive and the latest control systems for ultra-smooth, quiet operation, whilst the all-new remote controllers display live information to the operator helping them monitor speed, inclines and battery life etc... from a safe distance. Check out the wide range of accessories that can tailor the carriers to specific tasks.



Trackunit: Stand MP42

Global IoT/telematics services provider Trackunit delivers data and insights to companies operating in the off-highway market, helping eliminate downtime. It will launch its Service Management tool that, it says, will enable equipment owners to increase their total return on assets, optimise parts provision for manufacturers and drive down fleet owner costs. The tool also dovetails



Get the Top!

NEW ELSA H20-50
Construction hoist
up to 5000 Kg
and 500 Mt height,
available in single or
twin cage variants

SEE US ON STAND 605!

Made in **ITALY**

Construction hoists. MCWP. Transport platforms

electroelsa.com

with a new My Network app which will enable fleet managers to quickly diagnose and remotely resolve up to 75 percent of equipment related issues.

On the stand: Service Management App

Trojan Batteries: Stand MP21 and 510

See DC Battery Technologies and TVH

TurboPrecleaner: Stand 510

See TVH

TVH: Stand 510

Global parts and accessories supplier TVH will promote several of its operations at Vertikal Days including the TVH University, Outtriggerpads and Energic Plus. The company plans to exhibit one of its fully equipped service vans which provides spare parts such as joysticks, controllers and switches etc... It will also demonstrate its tyre foam filling service and display a range of polyethylene outrigger pads, spreader plates and crane mats.

Energic Plus specialises in industrial batteries, battery chargers and technologies that can help extend battery life. Its flagship product is the Energic Replus battery regenerator which revitalises any lead-acid battery by removing sulphation via a series of high frequency pulses.

TVH University offers hands-on technical training, suitable for a wide range of industrial machines. The courses are recognised by IPAF and supported by DataDock in France and Educam in Belgium.

On the stand: TVH University, Outtriggerpads, Energic Plus



Universal Crane Mats: Stand 210

Universal Crane Mats will show its full range of crane mats and outrigger pads, including its UniMat aluminium, steel, timber and polymer options for both sale and rental.



UpRate Digital: Stand MP22

First time exhibitor UpRate will unveil its bespoke construction targeted recruitment platform. Users upload their details via a mobile app to create a digital worker profile allowing greater insights into an individual before they turn up on site. Information includes previous site performance ratings, familiarisations, safety critical medicals, DNA history as well as many other insights into their character, competency and experience.

On the stand: UpRate platform

UpRate



See our range of lifting and hoisting equipment on Stand MP15

CarlStahl®

**Vertikal
days**

www.carlstahlevita.co.uk



Looking for dealer in each country!

US Battery: Stand MP8 and MP9
 See Battery Service Hub and Ecobat Battery

Valvoline: Stand MP24
 See Alliance Automotive Group

Van Beest Green Pin: Stand MP48
 See Lifting Gear Products

Verope: Stand MP43
 See Latch & Batchelor

Vertikal Press: Entrance



The Vertikal Press is the leading independent provider of news and information to the lifting equipment industry. It publishes the English language Cranes & Access magazine, along with the leading German publication Kran & Bühne as well as the industry renowned news service and information database www.Vertikal.net. It is also the organiser of Vertikal Days. Be sure to come and say hello to the team.

William Hackett: Stand MP48
 See Lifting Gear Products

Winlet: Stand 303
 See Hird

Wippermann: Stand 510
 See TVH

Woods Powr Grip: Stand 206/308
 See GGR Group

Xenith Heights: Stand MP47

Specialist working at height product provider Xenith Heights will show its latest generation of Aresta height safety personal protection equipment and Gripps tool tethering products. New products for this year include the newly designed Aresta helmet and upgraded Scaffold Harness.

On the stand: Aresta Height Safety Equipment, Gripps Tool Tethering

Xona: Stand MP15
 See Carl Stahl Evita

Yoke: Stand MP48
 See Lifting Gear Products

Xenith Heights



THANK YOU FOR VISITING VERTIKAL DAYS 2023

The Vertikal Days team and its exhibitors would like to thank you for supporting the show. We hope that your visit proved enjoyable, valuable, educational, stimulating and that you had the chance to meet with plenty of old friends and new contacts.



SEE
 YOU IN
 2024

A BIG THANK YOU TO OUR EVENT SPONSORS:



i 5000 SERIES

**Vertical
days**
STAND
MP33

NEW PRODUCT NEW DESIGN AND USER EXPERIENCE



RAYCO ELECTRONIC SYSTEM LTD

CANADA

+1 418 266 6600

UNITED KINGDOM

+44 1424 421 235

UNITED STATES

1 888 252 1957

EGYPT

+2 022 447 3896

SINGAPORE

+65 6908 1127

RaycoWylie
RAYCOWYLIE.COM

CRANES WITH VIBRO HAMMER

ADVERTISEMENT

Effectively minimizing vibrations and shocks



Mobile cranes (both wheeled and crawler) with lattice or telescopic booms are designed to lift and move free-hanging loads. Mobile crane manufacturers and users have now recognized the risks of using mobile cranes in conjunction with free-hanging vibratory equipment for pile driving and extracting operations.

For this reason, the FEM (European materials handling federation) and the well-known manufacturers affiliated with it recommend the use of vibration dampers for such applications. Likewise, many crane rental companies are beginning to rent out vibration equipment only in conjunction with vibration dampers in order to prevent damage to the crane.

Highly effective vibration dampers for carrier equipment have been developed by the specialist for pile driving and extracting technology, TÜNKERS from Ratingen, Germany, and have been successful with them for many years.

The damper is ideally suited for use on mobile cranes in conjunction with freely suspended vibration equipment for pile driving and pulling work, but at the same time also for transporting sensitive loads and vibration-sensitive goods.

CONVINCING FUNCTION

The function of the vibration damper/shock absorber can be described as follows: The vibration-isolating function is performed by a horizontally arranged hollow rubber spring loaded in compression. As the tensile force increases, the angles decrease, causing the compression load

on the hollow rubber spring to decrease proportionally in tensile force. This makes it practically possible to introduce high tensile forces (large pre-tensioning forces for heavy drawing work) into the pile-driving and drawing equipment without overloading the hollow rubber spring. Simultaneously with the flexing of the hollow rubber spring, the geometrically arranged rope strands cause the lateral pressure plates to oscillate about the upper pivot points. This eliminates, even under maximum tensile load, the vertical vibration introduced by the pile-driving and pulling equipment and does not transfer it to the pulling rope of the carrier.

Tünkers vibration dampers are available in five designs and can therefore be used for almost all applications. The maximum permissible pretensioning force of the devices ranges from 120, 160, 250, 500 up to 800 kN.

Independent tests have shown that oscillations and vibrations are reduced by up to 93% by TÜNKERS vibration dampers. VMS Australia, a company specializing in vibration monitoring, carried out measurements for this purpose. VMS installed four different measuring points on the crane. Above the hook, at the tip of the boom, in the middle of the boom and in the cab. Different types of vibratory hammers were used to test the different forms of vibration. It was found that the TÜNKERS dampers absorb up to 75% of the shock load vibrations due to starting and stopping and up to 93% of the peak frequency vibrations during operation.

Thus, the TÜNKERS vibration dampers significantly reduce the general wear of the leading crane and likewise reduce the strain on the crane operator.

USE IN AUSTRALIA

TÜNKERS vibration dampers were recently able to record an extraordinary application in Australia. The company Mitchell Marine Constructions specializes in shipbuilding and realizes projects such as the construction of wharves, bridges and boat ramps. Pile driving is an important part of their work, and the use of vibratory hammers and hydraulic hammers are essential here. Mitchell Marine Constructions was involved in a project that used a vibratory hammer on an all-terrain hydraulic crane. „This is the first time we've used a vibratory hammer on an all-terrain hydraulic crane, and the end result was great. We installed four piles, two steel piles and two fiberglass piles, and there was minimal vibration,“ reports General Manager Chris Mitchell.



BENEFITS AT A GLANCE

In conclusion, the benefits of the vibration damper can be summarized as follows:

- The vibration damper reduces the high dynamic alternating forces generated by the pile driving and pulling equipment.
- This prevents damage to the telescopic crane used as the carrier.
- Efficient vibration isolation is achieved by combining a special, heat-resistant hollow rubber spring with a simple but effective joint design.
- Absolute safety even under heavy loads is guaranteed by a double-sided hanger and the self-centering, non-kinking hollow rubber spring.
- The applicability for pile driving and hauling is versatile.
- The vibration damper is also ideally suited for transporting vibration-sensitive goods.



TÜNKERS
Ramm- und Ziehtechnik

TÜNKERS® Maschinenbau GmbH
Am Rosenkoth 4-12
D-40880 Ratingen
Fon: +49 (0) 21 02/45 17-0
Fax: +49 (0) 21 02/45 17-9999
E-mail: info@tuenkers.de
www.tuenkers.de



CONEXPO TRANSFORMED...

It is amazing the difference three years can make. Conexpo 2020 was due to be the largest for many years, but was hit by the rapid approach of Covid 19, leading to the event closing almost two days early.

This year Conexpo was back and bigger than ever, with the organisers claiming almost 140,000 visitors for the three co-located events - Conexpo, ConAg & IFPE - with 20 percent of them coming from overseas - an increase of 8,000 on the Covid affected 2020 event. This year was busy - particularly when the sun shone later in the week - and most importantly it had a very positive 'vibe' throughout. This translated into orders, according to exhibitors we spoke with, a great deal of money was spent at the show on equipment of all shapes and sizes.

SPREAD OUT ALL OVER

Unfortunately, this year's extended layout meant that getting from one area to another was even more protracted than last time, taking up to 30 to 40 minutes to go from the Festival Grounds - where most crane, access and telehandler exhibits were located - to the Silver Lot or Central Hall.

THE MISSING

As we have previously reported, several major manufacturers including Manitowoc, Genie, JLG, Bronto, Ruthmann and Wolffkran decided not to attend. Some due to its proximity to the postponed Bauma last October, and some due to increasing costs to exhibit and long lead times.

One surprise though was the appearance of two Grove cranes on the Broderson stand. Broderson

is part of Lanco, which also owns Manitowoc/Grove distributors Mi-Jack and Walter Peyton. It seems that a complaint was made, regarding a rule preventing non-represented manufacturers from exhibiting. As a result, Manitowoc popped up on the official exhibitors list just before opening day suggesting, perhaps, that a payment for the space had changed hands? Or was it just trade show gossip?

Thankfully for those on this side of the Atlantic the missing manufacturers will be at Vertikal Days next month.

The 'no shows' and the proximity of Bauma, did limit the number of big new product launches, however there was still plenty to see. With magazine space limited in this issue, we will try to convey a flavour of the show in pictures and cover new products in our features section over the remainder of the year.

STAND OUT EXHIBIT

To answer the question: 'What was the one exhibit that really stood out?' It can only be the maddest 30.5 metre/22 tonne Xtreme XR50100 quad track telehandler named 'Trackzilla' with tilt cab and an overall weight of 60 tonnes.

Conexpo will return to Las Vegas in March 2026. If you have never been to Conexpo or Las Vegas - you have to do it at least once...



Xtreme 'Trackzilla'



Liebherr 470 EC-B tower crane



Kobelco CK2000G3 - just part of the cowboy themed stand



Grove TMS 875-2 on the Broderson stand.



Broderson's new 20 ton RT-400



130 tonne Liebherr LRT 1130-2.1 with 60m main boom



Sunward SWTH1056 telehandler



Snorkel 2100SJ



Terex Commander digger derrick



Liebherr LR 1400 SX



LGMG first mast boom in North America - the M2640JE



Imer stand



Hinowa was tucked away in the new West Hall

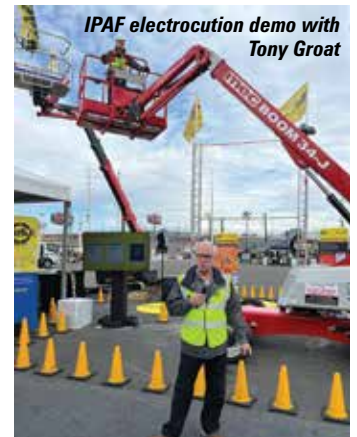

IPAF electrocution demo with Tony Groat



Xtreme tilt construction telehandler attachment



There was a lot of interest in the Snorkel and Xtreme products



Skyjack SJ1256 THS 17 metre telehandler is being produced at its new facility in Mexico



Jekko JF articulated tracked cranes



Link-Belt stand with the new 250 tonne 300AT All Terrain and the 110 tonne 120TT Truck Terrain crane



Merlo 50.35 S Plus EE4 CVTRONIC Roto telehandler

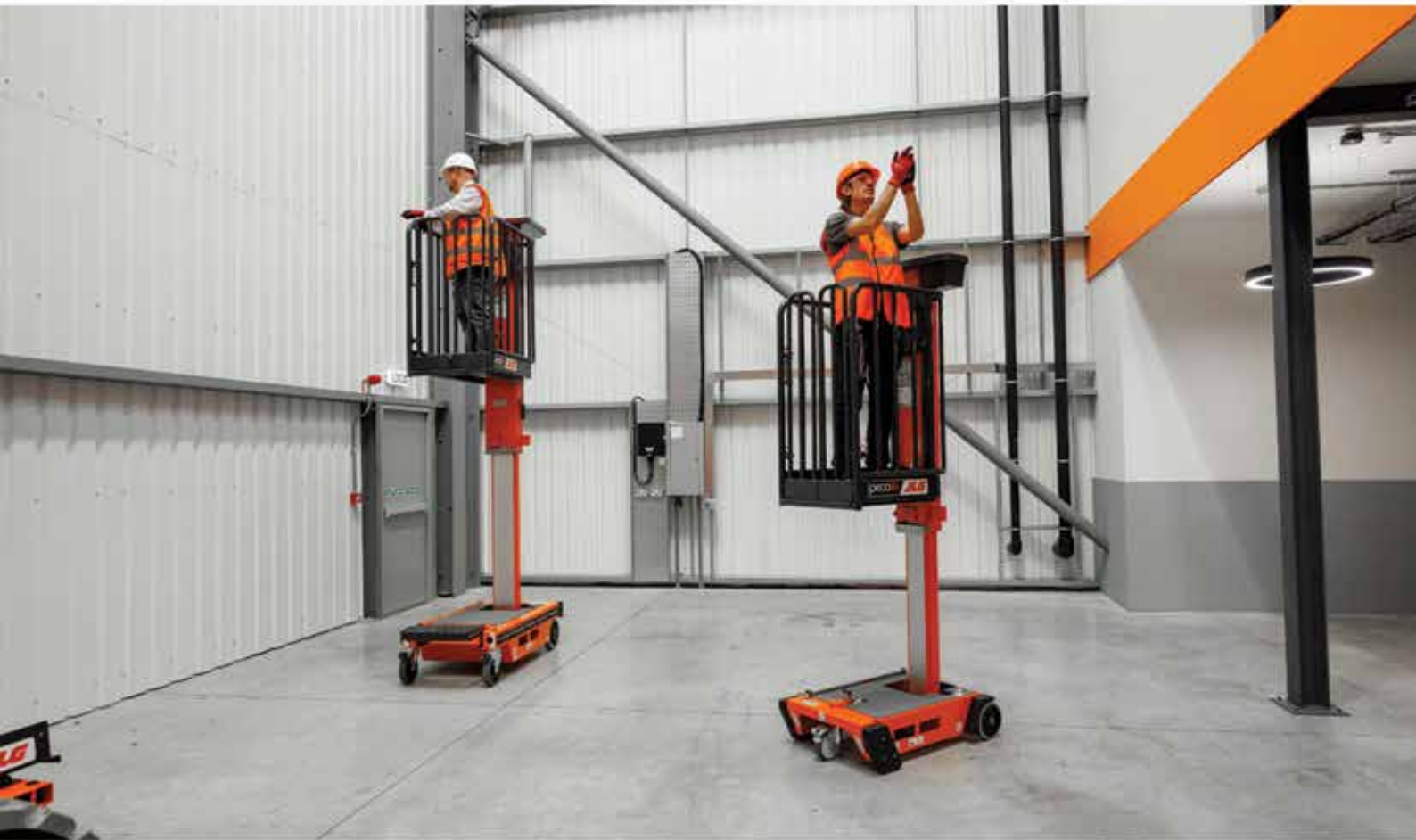

Low-Level Access by JLG Power Towers. A smarter way to work.



Work Safely: Using one of the PowerTower range of modern alternatives to ladders, scaffolding or podium steps.

Work Stress-Free: Our ergonomic design allows operators to work comfortably over longer periods of time, while reducing the potential for musculoskeletal injury, stress, and fatigue.

Work Efficiently: The benefits of working at height safely and comfortably include improved work efficiency, increased worker morale, reduced sick pay and workers' compensation claims, along with decreased absenteeism and employee turnover.

PowerTower, Nano Push, Ecolift and Pecolift are now available to order with anti-climb vertical rails.



Platform Basket stand



Sinoboom scissors



The Jaso derrick crane



Sunward SWSL6094RT scissor



Merlo E-Worker 25.5-90 4WD



LGMG scissors including the new SR2669D

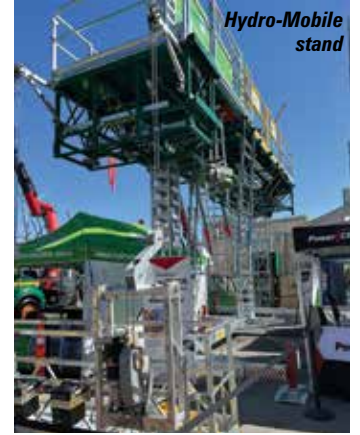

Hydro-Mobile stand



Tadano e-Pack



Palfinger PK 135.002 TEC 7 on a Mack truck



One of several really good bands keeping visitors entertained - these were on the Sany stand



Palfinger pick up mounted platform



Sany SCA1350A lattice crawler crane



Sinoboom celebrated 15 years at the show



Tadano GR-1300XL



The new Sogace Raptor brand includes three new models



TVH stand



Hetric stand



IMT stand



Liebherr LTM 1100-5.3 - 100 tonne 62m main boom



Tadano GR-1000XLL EVolt showing the inverter and motor



Xtreme Trackzilla



Zoomlion ZRT11D543



MEC Nano10-XD



Kobelco CK1600G-3



Ormig 55 sold to Baker Rigging



Versalift articulated boom on a Terramac RT9 U tracked chassis



Wacker Neuson TH412



Schaften Cranes
Worldwide Bare Rental

We master gravity

This is what superior lifting looks like. Delivering cranes with heavy lifting capacity and various configurations we master the toughest of lifting challenges. With our cranes any job becomes a safe and feasible task, any lift can be conquered.

schaftencranes.com

Panoramic 120.10

Don't settle for second best



 LIFT CAPACITY 12	 ENGINE 170	 LIFT HEIGHT 9.8
---	---	--

This heavy duty model has been developed to offer greater lifting capacity while maintaining complete safety. The axles with epicyclic reducers are equipped with oil immersed brakes. The cab is on a higher position in order to ensure that the operator has better visibility. Visit merlo.co.uk to find out more.



merlo.co.uk

An aerial view of a construction site featuring a large blue tower crane. The crane is positioned on a concrete structure, and its jib extends across the site. The surrounding area shows various construction materials and structures.

Integrated Lifting Solutions

JRL
LONDON TOWER CRANES

+(44) 0208 327 4060
sales@londontowercranes.co.uk

- The UK's leading tower crane provider
- National coverage with a local presence
- Over 200 Cranes in fleet
- Average age of crane fleet under 5 years old
- Full inclusive service ranging from initial design, erection, service, maintenance and dismantle



Maeda MC815C



Magni RTH 6.30



Sany telehandlers



Cormach 240000A



Bailey Cranes scissor with protection



Almac T-Crane 1600 EVO

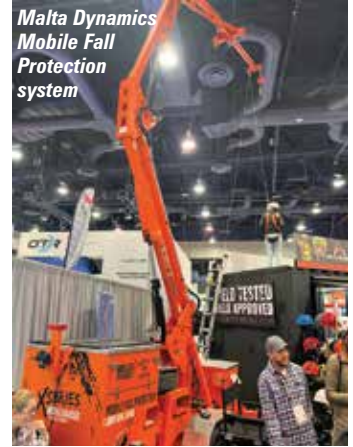

Malta Dynamics Mobile Fall Protection system



David White of Mec with the New MME 30-RJ mast boom



Goldhofer blade mover



Dingli stand



Bobcat TL519



Manitex TC85159



Sany Rough Terrain cranes



Manitou MRT3570 roto telehandler

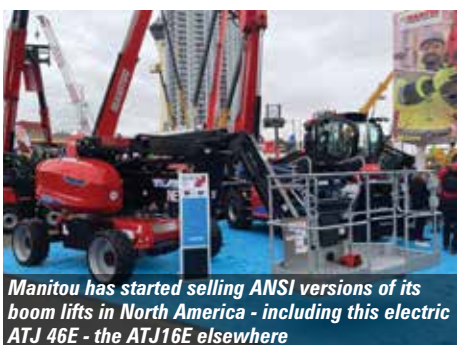

Manitou has started selling ANSI versions of its boom lifts in North America - including this electric ATJ 46E - the ATJ16E elsewhere



Manitex AL68 tracked mounted lift



Pettibone Extendo 1544X

APEX
2023
MAASTRICHT
10th EDITION
6 - 8 JUNE

**The International Access
Platform Exhibition**

**APEX returns to MECC
Maastricht in 2023:**

The key show to revitalise the market

REGISTER ONLINE FOR A FREE ENTRY

Visit **apexshow.com** and click
on **'VISITOR REGISTRATION'**

Sponsored by:

access
INTERNATIONAL

Supported by:

IPAF

khl

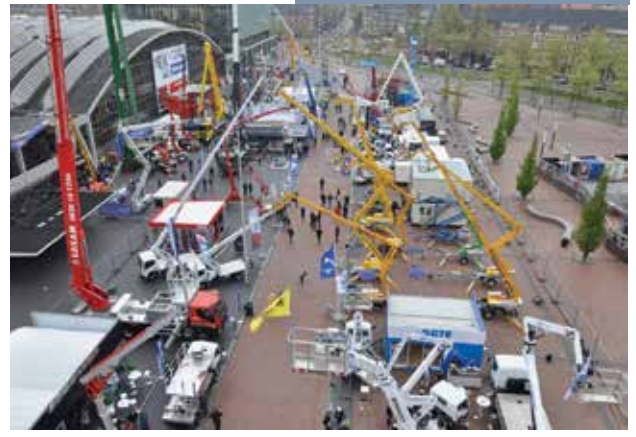

APEX IS BACK

The Dutch access exhibition APEX returns after an absence of six years following the cancellation of the 2020 event. It also returns to Maastricht for the first time in 12 years having moved to Amsterdam following the 2011 show. It returns at a period which while uncertain, is still optimistic. Most major aerial lift manufacturers will be exhibiting, including a fair few Chinese companies that you might never have heard of. Among the 120 or so exhibitors you will also find a good few component and service suppliers and even a few rental companies such as Mateco. A full list of exhibitors is provided below complete with stand numbers.



APEX is one of the few opportunities to see a type of crawler boom lifts that are particularly popular in the Netherlands from Rhinox and Hyrax

Events to be held alongside the exhibition:

Wednesday June 7th and Thursday June 8th

The ERA Convention 2023

The European Rental Association will hold its annual Convention at the MECC exhibition centre on the 7th and 8th of June and will include the association's European Rental Awards, and run alongside the International Rental Exhibition.

Thursday June 8th

IPAF Women in Powered Access networking breakfast

IPAF will host the very first Women in Powered Access networking event in the Brasserie Saam at the MECC exhibition centre on the 8th June from 8:00 to 9:30 as part of IPAF's Women in Powered Access initiative which sets out to encourage more women to join the industry and develop their careers.

IPAF president Karin Nars will give an overview of the initiative and outline the project goals and objectives. The event is intended to provide an opportunity to meet other women in the industry and hear more about the project.

The event is free of charge, but you do need to register at:

www.ipaf.org/en-gb/upcoming-events

WHAT CAN YOU EXPECT TO SEE?

Rather than do the typical preview and then review covering much of the same material, we hope that this preview will provide some indication of what to expect at the show, along with all of the practical details and events going on over the three days.

Sustainability and electrification

Sustainability and the environment are becoming

the 'buzz words' of our time, and most exhibitors will certainly be focusing on them, along with social consciousness and diversity. Regarding the latter two you might watch out for 'greenwashing' and posturing of course, but while there will be some of that, an increasing number of companies in our industry are getting really serious about all of these subjects. A short conversation or a simple look at what is done, rather than what is said usually provides the answer. Having started with a cynicism there will be plenty of great new products to look over and ideas on how your business might benefit.

Self-Propelled lifts

Booms

You will certainly see plenty of all-electric boom lifts that are now a truly practical reality, as long as you have the infrastructure to charge them of course, but there are a fair few battery and charger suppliers exhibiting that can help you with that issue. If not, then the latest hybrid models will also be on display. As for something a little different Niftylift can update on its Hydrogen fuel cell trials, in which a small hydrogen gas cylinder can provide several complete battery recharges before needing to be changed. And while on boom lifts with a difference, APEX is one of the few opportunities to see a type of crawler boom lifts that are particularly popular in the Netherlands and North Germany, with local suppliers Rhinox and Hyrax both exhibiting alongside JLG which also offers similar lifts, while Snorkel and Genie have quad track versions of their mid-size boom lifts. Finally AlmaCrawler will have its rubber tracked self-levelling models on display. If lighter weight booms are of interest Dinolift will have its new 86ft electric powered 280 RXTE on show.

Scissor lifts have of course been largely electric



from the start. The latest developments include lithium battery options - which offer higher running times per charge, while more importantly being virtually maintenance free with a long service life - the emergence of all electric Rough Terrain scissor lifts and a growing number of companies manufacturing high narrow and heavy duty models. Staying on the electrification front, most self-propelled manufacturers are talking direct electric wheel motor drive for greater efficiency and fewer hydraulic joints to leak.

Dates: June 6th - 8th

Venue: MECC Exhibition Centre, Maastricht

Opening times: June 6th & 7th: 9:30 - 18:00

June 8th: 9:30 - 17:00

Spiders everywhere

Moving on to spider lifts, all of the major suppliers will be present several promoting larger machines topped by Palazzani with its 58 metre model shown as a prototype at Bauma, and Easylift with its 53 metre model. Also the original manufacturer Falcon (Falck Schmidt) will be there and interested to discuss 50 metre plus machines, while fellow Dane Ommelift has also been busy. Getting back to electrification, most spider lift manufactures now offer lithium power options or even as standard. The lithium pioneer Hinowa has started shipping its new 40 metre so hopefully you will see the full production version



Easy Lift will be showing its 53 metre spider lift

on its stand. If you have not seen Goman's spider lifts before then it is worth stopping by to say hello, the Chinese manufacturer has been present in the North American market for some time but is hoping to do more in Europe. Last and certainly not least, CMC will have its new 27 metre S27 and sister machine the 30 metre S30, but more importantly it will hopefully be making fresh cannoli on its stand, as it did at Bauma.

Vehicle mounted lifts

If vehicle mounted lifts are your thing the increasingly competitive market has led to a plethora of new models and developments. Multitel - which also has its spider lifts on display - Palfinger, Comet, GSR, Klubb which now also owns Isoli and the Time group which now includes France Élévateur, Movex, Ruthmann and Versalift all have plenty to show and plenty to talk about. Once again, we return to electrification -



Klubb bamboo decking

most van and truck mounted lift manufacturers are now offering hybrid models, which use a standard chassis with an electric powered upper, the best of which can be recharged while travelling between jobs, run off the PTO or plugged in. In addition, several suppliers will also have all electric models, with a battery electric chassis as well as an electric top. Finally, if you missed it at Bauma you might ask how Klubb is getting on with its clever bamboo decking and tool boxes - certainly more sustainable than aluminium.

Other equipment

While promoted as a dedicated access exhibition, most of the major spider crane manufacturers will be represented, including Jekko, Hoefflon, Maeda and Unic. It seems that spider and mini cranes often fit better with aerial lift rental companies. Continuing with other products, if you are not familiar with battery electric telehandlers check out the Faresin stand where you can see its increasingly popular 626 Full Electric and finally the show also presents an opportunity to look at glass handling robots, both on the spider crane stands and Winlet which builds dedicated machines.



Hyrax ATD 50.13

EXHIBITOR LIST

Exhibitor	Stand No	Hoefflon	1395	Omme Lift	1440
Almac /AlmaCrawler	1120	Holland Lift	350	Onder Grup Makine	1035
Alp Lift	670	Hong Kong Quimo Power	510	Palazzani	1460
Altrex	310	Hunan Aerial Power	815	Palfinger Platforms	1000
Amer	125	Hyrax	1390	PB Lifttechnik	410
Axolift	475	I-Lift	315	PG Trionic	245
Bini	270	Imer	520	Platform Basket	540/1580
Bluelift - Ruthmann	1040A	Imet	735	PM Oil & Steel	1560
Bravi	250	Inter Control	150	PowerFirst Technology	166
Bronto Skylift	1420	Interpump Hydraulics	545	Qingdao Xingye Exhibition	805
C.M.C.	1320	IPAF	210	RB Componentes	355
Camm Group	825	Isoli - Klubb	1280	Rhinox	1540
Carpenter	813	Italift	316	Rima	446
CO.ME.T.	430	Jekko	640	Rolls Battery Engineering	725
Cobo	516	Jiangsu Topower Tyre	807	Ruthmann	1040A
Collé Rental & Sales	1260	JLG	220	Seastar International	1020
Cranes & Access magazine	376	Jovoo Industries	603	Sensata	730
CTE	1480	Kaulas Lastik	506	Shandong Chufeng	501
Custers	140	KHL	300	Shandong Kinglift	1025
Delta-Q	406	Klubb	1280	Shandong Qiyun	1030
Dingli	530/1290	Kran & Bühne	376	Shandong Rees	526
Dinolift	1220	Kuzar Systems	600	Sinoboom	360
DIS Sensors	803	Lift IQ	405	Skyjack	320
Dynaset	375	Liftbay	165	Snorkel	450
Easy Lift	1340	Liftroller	660	Socage	1380
ELS Lift	260	LGMG	420	Spring	720
Exmile Special Tyre	356	Liugong	830	Sunward	840
Falcon Lifts	1100	Lodax Pads & Mats	505	TCLift	170
Faraone	560	Loyal	316	TGB Group	155
Faresin	1490	M.E.TA.	800	Trident International	130
France Élévateur	1260	Maeda	550	Trojan Battery	525
Fronteq	650	Magni	1360	TVH	460
Fullriver Battery	515	Manitou	330	U.B.S.	500
Gefas	230	Mantall	940	Unic	405
Genie	340	Mateco	465	Vary Software	160
Goman	466	Merlo	1430	Versalift	1040B
GSR	235	Meta Hydraulic	470	Vertikal Press	376
Haulotte	850	Moba	120	Vertimac	240
Hefei Tianyu Booen Technology	820	Multitel Pagliero	1240	Wetac Motive Power	445
Hematec	230	Nagano	400	Winlet	565
Hered Lift	305	Niftylift	740	Xia Men Lanli	810
Hidrokon	370	North Valley Research	240	XCMG	620
Hinowa	1020	Oleodinamica Panni	545	Zoomlion	630

LESS MAINTENANCE MORE UPTIME GENIE ELECTRIC

VISIT GENIE® BOOTH #340 AT APEX



Genie®

QUALITY BY DESIGN

LEARN MORE AT [GENIELIFT.COM](https://www.genielift.com)



VISIT GENIE APEX BOOTH #340
APEX SHOW 2023, JUNE 6-8
MAASTRICHT, THE NETHERLANDS



TRIDENT
INTERNATIONAL PVT. LTD.

TRAXTER
MEWP Tyres by Trident

Introducing a Unique, Patented Tread Pattern for Boom Lifts US Patent: D813793

Features

- Non Directional High Traction R4 Pattern
- Heavy Duty Casing
- Optimized Inner Void

Benefits

- Common SKU for Left & Right Fitment
- Damage Resistance
- Low Tyre Fill Consumption

Sizes

- 315/55D20, 355/55D625, 15-625, 18-625

Also available as ready to fit foam filled assemblies

INDIA: Survey No. 70/A, Rashmi Industrial Estate, Wanawadi, Pune - 411 040 India Phone: +91 20 40092355, Email: salesteam@trident-intl.com

www.trident-intl.com





ALLMI
Setting the Standards for the Lorry Loader Industry

LORRY LOADER OPERATOR TRAINING
Approved by CSCS

Other courses approved by CSCS:

- Slinger / Signaller
- Crane Supervisor
- Appointed Person
- Thorough Examiner

Courses also available for:

- Instructors
- Managers



ALLMI
Setting the Standards for the Lorry Loader Industry

A. N. Other
Categories: Lorry Loader
Capacity up to: 20TM
Category: 01+02
Expires: 22-03-24
ID Number: 211013

Lorry Loader Training Commissioned by the Health & Safety Executive



BLAD
Trade Association Member

The Trade Association for the Lorry Loader Industry
Tel: 0344 858 4334 • Email: enquiries@allmi.com
www.allmi.com



ALLMI
Setting the Standards for the Lorry Loader Industry

ALLMI accredited Lorry Loader Operator Training Providers

Nationwide

PALFINGER UK

Contact: Sunny Patel
t: 01380 722381 m: 07483 039588
Email: sunny.patel@thwhite.co.uk
www.palfinger.co.uk
Dezives, Bradford and Falkirk

Nationwide



LorryLoader Training Ltd

24, Mayfair Drive, Crewe, Cheshire, CW15BB
Tel: 01270 505 824 Mob: 07970061171
Web: www.lorryloader.co.uk

Nationwide

ATLAS CRANES UK LTD

Wharfedale Road, Euro Way Ind. Est. Bradford. BD4 6SL
Tel: 08444 996688
Neale Martin: 07836 238281
Web: www.atlas-cranes.co.uk

Nationwide



Hiab Ltd

Cargotec Industrial Park, Ellesmere, Shropshire, SY12 9JW
Tel: 07792 831869
e-mail: wayne.ctsl@gmail.com • Web: www.hiab.com

Are your Lorry Loader Operators properly trained? Call an accredited ALLMI training provider and insist on the ALLMI card.

The training accreditation service for the lorry loader industry
ALLMI, Unit 7b, Cavalier Court, Bumpers Farm, Chippenham, Wiltshire. SN14 6LH.
tel: 0344 858 4334 email: enquiries@allmi.com web: www.allmi.com

ALLMI TO SUPPORT GLAD 2023

ALLMI will once again be a partner for the Global Lifting Awareness Day (GLAD), which takes place this year on the 13th July. Running for its fourth consecutive year in 2023, GLAD is a collaboration between a range of organisations involved with lifting or working at height. GLAD's aim is to promote the lifting industry, with particular emphasis on good practice, compliance, innovation, and attracting new recruits to the sector.

Look out for further details in due course and learn more about GLAD by visiting: www.globalliftingawarenessday.com



RECORD YEAR FOR ALLMI TRAINING

ALLMI has reported record overall training levels during its 2022/23 financial year.

Courses for Lorry Loader Operator, Crane Supervisor, Appointed Person and Thorough Examiner all experienced their greatest ever uptake, with Slinger/Signaller, Instructor and Manager courses also having an excellent 12 months and training levels rising by more than four percent overall.

ALLMI has long been regarded as delivering the lorry loader industry's leading training programmes and these latest figures further underline the scheme's increasing popularity. Developed by the industry, for the industry, ALLMI courses are approved by CSCS and delivered to the highest standard. For further details, please visit www.allmi.com/training or contact ALLMI.



STRAP DOWN YOUR LOADER CRANE! - REMINDER

This time last year - following reports of an incident that could easily have had fatal consequences - ALLMI launched its Strap Down Your Loader Crane! campaign.

If a loader crane cannot be folded for travel, and in the absence of manufacturer or employer instructions to the contrary, it should always be strapped down securely to the vehicle bed. Failure to strap it down could result in uncontrolled slewing while travelling with the boom moving outside of the vehicle's width, not only leading to damaged equipment and property but also injury or fatality to persons as well as criminal prosecution for the driver.

In addition to reaching out to fleet owners and operators, ALLMI's Strap Down Your Loader Crane! campaign is aimed at all businesses involved in the movement of lorry loaders, including crane installers, bodybuilders, truck dealers and delivery companies. The campaign supplies a range of valuable resources for employers to utilise, from training videos and 3D animated accident reconstruction, through to an information leaflet and toolbox talk template. All resources can be found on the following campaign-dedicated web page:

www.allmi.com/strap-down-your-loader-crane



PART 2-4 REVISION COMMENCES

The revision of BS7121 Part 2-4 'Code of practice for the safe use of cranes - Inspection, maintenance and thorough examination - Loader cranes' has commenced. A BSI Panel of industry experts recently held its first meeting and several more have been scheduled for the coming months.

Keith Silvester, ALLMI technical manager and convenor of the BSI Panel said: "The inaugural meeting was designed to establish the scope of the project, agree on a work schedule and allocate tasks where required. The entire revision process is expected to take between 12 and 18 months, although this will involve a two month public consultation window, allowing all industry stakeholders to comment on the draft produced by the Panel."

Look out for further updates in ALLMI Focus, and please contact the Association if you have any questions on this topic.

ALLMI MEMBERSHIP MEETINGS 2023

ALLMI has announced that its annual meetings for all members of the association - manufacturers/importers, service companies, fleet owners, ancillary equipment suppliers and site operators - will take place on 22nd June 2023 at the Forest of Arden Country Club in Meriden.

ALLMI chief executive Tom Wakefield said: "The Forest of Arden has provided an excellent setting for many successful ALLMI events and we very much look forward to returning to the venue. The meetings will facilitate valuable discussion and debate on a wide range of topical issues affecting the lorry loader industry, in addition to updates concerning numerous projects and activities being undertaken by ALLMI throughout this year. Our preparations will continue to take shape and we look forward to keeping members and the wider industry informed of developments in due course."



MET POLICE CPD

ALLMI technical manager, Keith Silvester, presented at a CPD event for the Commercial Vehicle Unit (CVU) of the Metropolitan Police Service (MPS).

Continuing ALLMI's ongoing work with the UK's Road Police, the presentation covered all lorry loader safe travel related issues, including safety system requirements, documentation and applicable legislation, as well as reviewing a series of accident case studies.

Sergeant Alex Burlison of the MPS comments "We have had a number of recent incidents with lorry loaders and so Keith's presentation was a valuable contribution to our CPD event. The information he provided will certainly benefit our CVU officers and further enhance the quality of roadside checks on lorry loaders, so that we can manage risk and take appropriate action at the roadside as we work towards the Vision Zero goal of making our streets safer."

Keith Silvester at New Scotland Yard, the venue for the CPD Event



For details of ALLMI standards, guidance documents and training, visit: www.allmi.com



WANT SUPREME PERFORMANCE IN EXTREME CONDITIONS?



YES, WITH TROJAN[®] AES.

The new Trojan AES battery handles the harshest of conditions, including extreme temperatures and neglect. This VRLA battery also maintains robust performance and delivers up to three times the cycle life of standard AGM batteries. Maximum runtimes, increased productivity and a much longer life.

Download data sheets and more at trojanbattery.info/YesAES. Say yes to Trojan AES.

VISIT OUR EXPERTS AT APEX
BOOTH 525



More Info



WINNERS OF THE IAPAS 2023 REVEALED IN BERLIN, GERMANY

The winners of the 2023 International Awards for Powered Access (IAPAs) were announced at a ceremony in Berlin, with the host location for the 2024 event announced as Copenhagen, Denmark. The winners were:

Access Rental Company of the Year

Sunbelt Rentals, UK

Contribution to Safe Working at Height

Nationwide Platforms, UK

The Sustainability Award

Genie, USA

Digital Development Award

Alimak, Sweden

Equality, Diversity & Inclusion (EDI) Award

Vicki Allen - International Platforms, UK

Innovative Technology Prize

Nationwide Platforms, UK - Harness On, Phase 2

Mast-Climbing Work Platforms and Hoists

Hoist, Italy - MBC2000 transport platform

Scissor Lifts and Vertical Mast Platforms

MEC, USA - MMAE16 vertical mast lift

Self-propelled Booms and Atrium Lifts

Manitou, France - 160 ATJ+e electric boom lift

Vehicle and Trailer-mounted Platforms

Elliott Equipment Company, USA - E150i truck mount

IPAF Training Centre of the Year

Dayim Equipment Rentals, Saudi Arabia

IPAF Training Instructor of the Year

Anna Sarah Costa Morais - Mills, Brazil

Access International/IPAF Lifetime Achievement Award

Dante Fracca, founder of Hinowa

Peter Douglas, CEO & Managing Director of IPAF, comments: "A very well-deserved congratulations to all the winners, and for all the companies or individuals shortlisted but not selected as winners this year, I hope you will enter the 2024 awards the winners of which will be announced in Copenhagen next March."

IPAF TO HOST DEDICATED WOMEN IN POWERED ACCESS BREAKFAST AT APEX

A breakfast event aimed at providing a networking space for women working across powered access will be hosted by IPAF during APEX 2023 in Maastricht, Netherlands, as part of IPAF's ongoing Women in Powered Access initiative inspired by IPAF's president Karin Nars. The special breakfast event will be hosted on Thursday 8-9.30am in the Brasserie Saam restaurant at the MECC, where APEX 2023 will be held. The event will be free, but attendees are asked to register in advance to reserve their place. Karin Nars will give an overview of the Women in Powered Access initiative, outlining key goals and objectives.

Visit www.ipaf.org/events for more details and to register.

VERTIKAL DAYS THE IDEAL PLATFORM TO PROMOTE IPAF SAFETY CAMPAIGNS

IPAF will use Vertikal Days 2023 on 10-11 May to promote IPAF's ongoing Don't Fall For It!, Load and Unload and High Voltage! safety campaigns. There will be a 'wheel of fortune' safety quiz for visitors to IPAF Stand 618, where participants can put their knowledge of safe loading and unloading to the test. All those who successfully pass the challenge will receive an exclusive sponsored water bottle courtesy of Warren Access.

IPAF chief executive Peter Douglas said: "Vertikal Days is one of the highlights of the UK powered access events calendar, and we are looking forward to catching up with colleagues across the industry to discuss how we can promote the safety campaigns and technical guidance together."

"IPAF's Global Safety Report shows how rental activity including loading and unloading platforms at

work sites leads to a significant number of incidents each year, with delivery personnel disproportionately at risk of serious injury, hence we are promoting our Load and Unload safety campaign alongside High Voltage! and Don't Fall For It!"



SAVE THE DATE FOR IPAF'S 40TH ANNIVERSARY EVENT

IPAF is hosting an event to mark its 40th anniversary the Belfry Hotel & Resort in the West Midlands, on 16th and 17th November, with an afternoon conference and dinner. The programme and booking will be announced shortly.



NEW ANDY ACCESS POSTERS AND TOOLBOX TALKS

IPAF has issued further IPAF Toolbox Talks and Andy Access safety posters, including briefings on: Operating MEWPs Alongside Roads. Avoiding Contact with Power Lines and Safety in Working Around RF Antennas. Developed in conjunction with Network Safety, IPAF members can access a 20 percent discount on Network Safety's Radio Frequency eLearning. Other IPAF member offers include discounts on fall-protection and IT equipment, software, subscriptions and training courses.

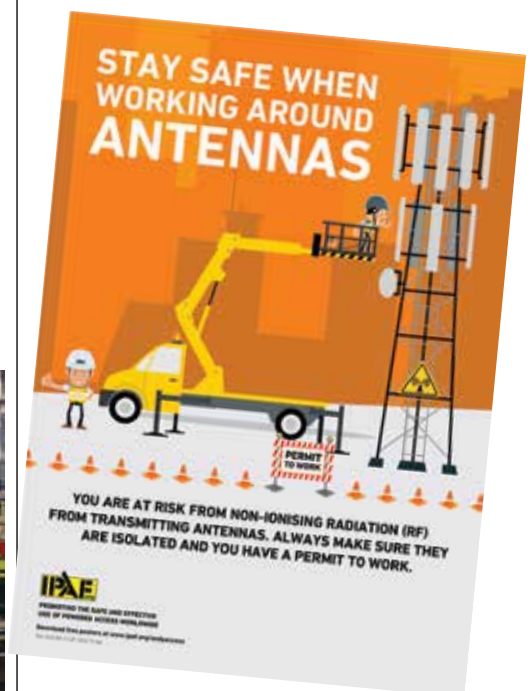

IN THE NEXT ISSUE OF

C&a

Place your products in front of 28,000 crane, telehandler and aerial lift buyers & users reading the June issue of **Cranes & Access**...



THIS ISSUE WILL INCLUDE FEATURES ON:

LOW LEVEL ACCESS

There's always plenty of new developments with low level powered access. In this feature we will cover push around and micro scissors and mast lifts including any recent launches or new techniques. If you have you got any news or information to add, please get in touch.



TELEHANDLERS

The telehandler market continues to evolve and develop, the issue will cover the latest development and product launches, from the new sub compacts right up to the latest monster launches and custom applications.

ALL TERRAIN CRANES

We take a look at changes that have been taking place over the past year, significant developments announced at Bauma that are beginning to go into production along with some interesting applications.



HIRING FOR THE INDUSTRY

Discussions at the IPAF summit in Berlin touched on the challenges our industry is facing with the recruitment and retention of a skilled, diverse workforce given the continued skills shortage. We take a closer look at these issues and the solutions available.

VERTIKAL DAYS 2023 REVIEW

This year's fully loaded Vertikal Days returns to the East of England Showground in Peterborough. With more than 270 manufacturers represented, it will be the biggest Access or lifting event in 2023. The issue will include a

taste of the new products on show.



Send any information, news, photographs or ideas on these subjects to editor@vertikal.net

Every issue of **C&A** is also packed with our **regular columns** and **news** plus **reader's letters, books, models, training**, along with the latest news from **CPA, ALLMI, IPAF** and **PASMA**.

Ask us about our **Special Advertising Packages** advertising@vertikal.net or call us on UK +44(0)8448 155900 or mobile +44(0)7989 970862

NEW TECHNICAL AND DEVELOPMENT OFFICER

The CPA has appointed Katie Kelleher as CPA technical and development officer, in this newly created role, she will provide CPA members with guidance and advice on technical, training and safety subjects, as well as help produce and maintain the CPA's range of safety and technical publications. She will also help represent the CPA on a number of industry led initiatives and working groups and liaise directly with members and various organisations.

She joins the CPA from Select Plant Hire, having started with the company in 2014 as the first woman to join the Lifting Technician Apprenticeship, having previously worked in a variety of sales and recruitment jobs. After completing the apprenticeship, she became a crane operator, working on jobs such as Crossrail and the Tideway Project. More recently, she has worked as an Appointed Person on a number of major infrastructure projects.

She has become known as a champion for attracting women and young people into construction and is a passionate advocate for the industry and apprenticeships. She has also served on the Strategic Transport Apprenticeship Taskforce and more recently joined the City of London Skills for a Sustainable Skyline Taskforce. She became acquainted with the CPA as a panellist at the association's



annual conference and has been a judge for the CPA's Stars of the Future Apprentice Awards. In 2021 she was declared one of the Top 100 Women in Construction and has been selected as a 'LinkedIn Top Voice'. She also made it onto 'Construction News 15 People to Watch' list in 2019.

"I am very excited to join the CPA in this role and truly believe I can be of value to the association and its members. I look forward to making a noticeable difference within the sector and helping take the CPA to the next level," said Kelleher.



Katie Kelleher

'SCHEDULE OF COMMON LIFTS' PUBLICATION

The Industry Lifting Lead AP Group, managed by Skanska and supported by the CPA, has produced a 'Schedule of Common Lifts' publication which provides guidance on lifting methods for a number of loads frequently lifted on construction sites.

The group was formed in 2015 and brings together expertise from industry to encourage collaboration and co-ordination for lifting operation activities and aiding communication between contractors, associations, suppliers, owners and training bodies etc.... The group seeks to provide guidance on standards, training and improved methods of working to make lifting operations safer and more efficient.

The schedule is designed to support both the training of lift planners on dedicated courses and provide additional guidance for the competent person planning or responsible for a lifting operation, supplementing the information that should be contained within a lift plan.

The group is keen to stress that the publication highlights good practice but is not a substitute for appropriate lifting operations planning. All lifting operations must be carried out in compliance with LOLER 1998 and the relevant standards eg BS 7121.

The publication can be downloaded free of charge at <https://www.cpa.uk.net/safety-and-technical-publications/mobile-and-crawler-crane-guidance>



CONSTRUCTION EQUIPMENT MAINTENANCE TECHNICIAN APPRENTICESHIP

Following the development and release of a dedicated construction equipment maintenance apprenticeship for mechanics at Level 2 in 2020, an employer working group, led by the CPA, has been working on a technician version of the apprenticeship at Level 3. This was submitted to the Institute for Apprenticeships and Technical Education (IfATE) in January and has now been approved.

Although a Level 3 maintenance apprenticeship exists for lift trucks and access equipment, this version caters for a wider scope of equipment and activities and includes topics such as dealing with new technologies, higher communication skills, in addition to traditional skills.

The working group has now commenced work on devising the required knowledge, skills and behaviours (KSBs) which will be followed by the development of the end point assessment that confirms that the relevant learning has been achieved. The apprenticeship could be ready for delivery this autumn.

VERTIKAL DAYS

The CPA will exhibit at Vertikal Days and also host a standalone open event during the show on behalf of the CPA Crane Interest Group and the Tower Crane Interest Group. The joint two hour event is open to all and will be held on Wednesday 10th May, the first day of the show. Topics will include Drop Prevention and Engineered Solutions, Alternative Energy Solutions, Routing and Authorities, Civil Aviation Authority (CAA) CAP1096 Update and the CPA Guidance - Procurement of a Mobile Crane.

For those wishing to attend, please register your interest with Rob Squires at rob@cpa.uk.net. More information on the event can be found at www.cpa.uk.net



ELECTRIC power

The **Snorkel SR626E** is the electric version of the SR626 rough terrain telehandler – an industry first. Its full-time 4-wheel drive is powered by lithium-ion batteries for long-lasting durable performance. Built compact, the SR626E is highly maneuverable with reduced noise and zero emissions that is suitable for indoor use.

100%
ZERO
EMISSIONS

93%
SERVICE COST
REDUCTION

62%
NOISE
REDUCTION

4X4
ELECTRIC FAMILY
FROM 5.79M - 16.3M

2-IN-1
WORK INDOORS
AND OUTDOORS



SR626E
CLEAN ENDURANCE

snorkel
snorkelnetzero.com



To arrange a demonstration, call **Snorkel UK™** on +44 (0)845 1550 057 or view our entire product line at www.snorkellifts.co.uk

snorkel
UK

RIWAL AND BLOM TRAINING JOIN FORCES

Dutch international rental company Riwal has formed a partnership with training specialist Blom Opleidingen for the provision of training courses for aerial work platform operators. Between them the two companies have 26 locations providing training, as well as offering on site courses.

The partnership will allow the two companies to offer their customers a greater selection and more availability by combining their individual strengths and networks. Blom Training is one of the largest trainers in the Netherlands covering warehouse material handling equipment such as forklifts, training more than 30,000 students a year across 21 locations. It is also an IPAF member.



F1 FALL COSTS 760K

McLaren - the Formula 1 racing company - was fined £650,000 plus £110,000 in costs following a fatal incident at its premises in Maidenhead in 2016 in which David Oldham, 55, an inspector from Zurich Management Services fell to his death.

Oldham was carrying out a structural inspection of McLaren's Paddock Brand Centre - a hospitality unit used by its F1 racing team - as part of a repair and maintenance update, when he fell from an upper floor. A HSE investigation found that McLaren had failed to properly assess the risks and put measures in place to prevent falls from height.

Oldham left behind his wife Patricia and five children. Speaking of the incident she said: "Davey was my husband for 14 years, we loved each other very much, he was the kind of man who would help anyone if he could, he had such a big heart and used to make me laugh so much. We were planning our retirement, travelling and seeing what new experiences we could explore together. I have been robbed of my husband, but poor Dave lost his life."

HSE inspector Saffron Turnell said: "Work at height is a high risk activity and falls can result in life changing injuries and death. It's the number one reason why people like David don't get home from work. Those responsible to ensure his health and safety failed to do so."



David and Patricia Oldham



MAKESHIFT PLATFORM COSTS £16K

UK installation company Renka was charged almost £16,000 in fines and costs after an employee was badly injured following a fall at a house in Frodsham, Cheshire in August 2021. The company had been hired to supply and fit windows and doors at the property. When Renka employees arrived on site to install skylights, they found that the scaffold tower provided was too large to be positioned in the area where it was required. As a result, they made their own platform by wedging scaffold boards between the roof joists and gaining access via external scaffolding.

One of them stepped from the roof onto the platform, at which point a board broke, causing him to fall five metres to the ground below. The man, 35, fractured his back and ribs.

The investigation found that Renka failed to properly plan the work at height or provide suitable equipment for it to be carried out safely. The company's employees had also not been provided with instructions as to how the work should be carried out, or adequate training for working at height.

HSE inspector Sara Andrews said: "The incident could have been prevented by the adequate planning and provision of suitable equipment, together with relevant training and instructions. It is fortunate that the injuries suffered by the employee were not more serious, or even fatal."



WHO TRAINED THEM THEN?

WALKING THE PLANK

When two men working from a scissor lift in a church needed to reach out over an obstacle on the ground, they used a folding ladder as a cantilever deck. The posture of the man on the ladder tells you how unsafe and insane this is.



CPL OFFERS FREE TRAINING OR CAP RENEWALS

UK vehicle mounted platform specialist CPL - part of the Klubb group - is offering free training to all CAP engineers on its van and pick-up mounted products. The UK population of these machines exceeds 3,000 units. The free training, scheduled to start later this year, will be conducted by CPL lead engineer Alastair Thorpe at its premises in Kettering, Northamptonshire.

GOING UP IN THE WORLD



A history of Simon Engineering, the development of the powered access industry and a lifetime as an engineer, by Denis Ashworth

Ashworth was a keen engineer and from an early age found himself in at the very start of the modern powered access industry.

His book is an unusual combination of autobiography and history of Simon Engineering Dudley, a pioneer of the powered access industry and at one time, the world's largest manufacturer of aerial lifts.

The coffee table sized book, is highly readable and includes around 150 photographs and drawings from the very beginning of the industry. It is a 'must read' for anyone who is interested in powered access, the hydraulic equipment industry or in comparing modern day engineering challenges with those of an entirely different era.

The book is available direct from the publishers at £19.50, plus £4.50 postage and packing.

- Continental Europe €23 plus €6.50 postage & packing
- Rest of world \$31 plus \$10 shipping

Ordering Information

Forename: _____ Surname: _____
 Address: _____
 _____ Post Code: _____
 Email: _____ Telephone: _____

Please make all cheques payable to 'The Vertikal Press Ltd'

I enclose a cheque for £24 (£19.50 + £4.50 p&p)
 I enclose a cheque for €29.50 (€23 + €6.50 p&p)
 I enclose a cheque for \$41 (\$31 + \$10 p&p)
 Please invoice me: _____
 Please debit my card:

Card No: _____ Issue No: _____
 Issue Date: _____ Expiry Date: _____ 3 Digit Security Code: _____
 Signature: _____ Date: _____

Please send completed order form to: The Vertikal Press, Box 6998 Brackley, NN13 5WY, UK. Alternatively, fax it through on +44(0)1295 768225 or scan & email info@vertikal.net

DON'T LOOK DOWN!

Paul Adorian has been involved in the crane and access rental industries for more than 55 years, starting out in 1967 as a salesman for Eddison Plant Hire, which become the first company to add truck mounted lifts to its rental fleet. In the following decade, he founded EPL and was one of the very first to import scissor and boom lifts into Europe. He went on to set up IPAF - the International Powered Access Federation - serving as its first employee and managing director - a role he held for until retiring in 2003. The book is a highly detailed personal history of his life in the crane and aerial lift industries and a 'must read' for anyone interested in aerial work platforms.

"A beautifully produced hardback book and a fascinating and thoroughly enjoyable read." Cranes & Access magazine

"This book is a real eye opener and will appeal to those who have been involved in the business for some time, while being a useful and interesting tome for those who are new to the business. I highly recommend it." Leigh Sparrow - Vertikal

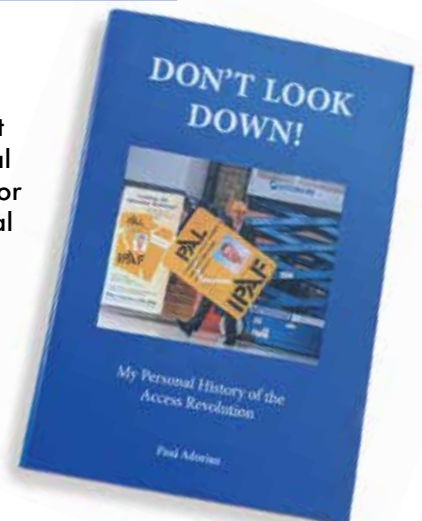

HOW TO ORDER

The book can be ordered direct from the author at pauladorian@outlook.com or if you prefer - Tel: **+44 (0) 1539 562699**. Or through the Vertikal Press on booksales@vertikal.net

Price: **£18** - including packaging

Postage/import costs

UK: £3:50 • Europe = £9 • USA = £19 • Asia = £15





Erection can be simulated



Distinctive hydraulic tower crane pose



Excellent jib profile



Detailed City Portal



Impressive looking model

WOLFF 166 B

The Wolff 166 B hydraulic luffing jib tower crane has a maximum capacity of 12 tonnes and a maximum radius of 55 metres and has been modelled in 1:50 scale by Conrad Models. The crane comes in a high quality box with a very detailed instruction manual and the various jib configurations of the real crane are shown and can be replicated with the model. However, assembly can be a little frustrating.

The base of the model is a City Portal and it is made up of several metal and plastic components which are mainly friction fit. The double height tower sections use thin plastic bolts for the connections and these work but can be hard to install and remove. Inside each section there are plastic ladders and platforms.

The slew ring and tower top are modelled well, and the hydraulic lift cylinder is a realistic looking part which luffs the jib by rotating the cylinder's barrel and it works with precision.

The cab deck is very good considering the scale and windscreen wipers are replicated by

graphics. There is an equipment cabinet, plastic handrails and a slew motor.

The counter jib has a nice mesh walkway with the counterweight with separate blocks. The jib is excellent and is made up of separate sections just like the real crane. The lattice work is of a fine quality with mesh walkways on the first section.

Two metal hook blocks are provided - a single line and a two fall block. The hoist winch works using a key, but the winch motor mounting is loose so care in operation is needed.

A feature of the model is that the tower can be built at different heights, and all the jib lengths of the real crane can be replicated. Most parts can also be used as truck loads. The crane can also be accurately displayed during various stages of erection.

Overall, this is an excellent looking tower crane model with some very good details. Assembly of the model can be a little frustrating, but it is worth it when complete. It costs around €285 from dealers.

CRANES ETC MODEL RATING

Packaging (max 10)	8
Detail (max 30)	25
Features (max 20)	17
Quality (max 25)	21
Price (max 15)	11
Overall (max 100)	82%

To see the full review, including a full unpacking and set up video, visit www.cranesetc.co.uk

10,000 Generators For Ukrainian Families

Plant & Hire
Aid Alliance



Scan here to visit our
JustGiving page

Power to Ukraine

Following several successful campaigns the Plant & Hire Aid Alliance has launched its latest appeal, which aims to send 10,000 desperately needed generators to Ukraine.

Why are generators needed?

Following repeated attacks on the power grid and other critical infrastructure, President Zelensky said that generators had become "as important as armour in helping Ukraine to survive this winter".

Ukraine needs you!

By donating to the Plant & Hire Aid Alliance appeal you or your company can make a real difference, providing life-saving winter heating to a desperate Ukrainian family.

"For just £270, you can send a generator to keep these families warm," said Jeremy Fish, the CEO of Ardent Hire and one of the founders of the Alliance. "We're appealing to colleagues around the world, to join us to help reach this ambitious target of 10,000 generators."



Targeted help

The Alliance has created a website where aid workers will register each recipient. This includes details of their family or group, along with a declaration that the generator will only be used for personal and humanitarian purposes.

69 Rotary Clubs across Ukraine will monitor the generators' use, confirming that they have been installed where need is the greatest and are being used as intended. "This not only maximises the impact of the campaign," explains Fish. "It also gives our generous donors the reassurance that their contribution is making a real difference."



Make a difference today

100% of your donation will go directly towards generator orders for immediate dispatch. Your donation, however large or small, will genuinely save lives.

Please help the people of Ukraine at this time of need.

Please donate or contact us through:

www.aid-alliance.com

Or visit:

justgiving.com/fundraising/ukraine-gensets



READERS LETTERS

ORIGINAL LIVERY RESTORED

Hi Leigh

I hope you are keeping well. Please find attached an image of our 1947 Cole's EMA Mark 7 mobile crane on a Thorneycroft chassis. This is the same model as the first crane purchased by our grandfather William Ainscough.

It was last displayed at the Haydock Plant Show about 30 years ago in Ainscough Crane Hire yellow and blue livery. Brendan, James and I decided it should be restored into our original family business livery.

I hope it will be of interest to your readers for the letters section of your magazine.

Best wishes

Martin Ainscough

If you have any historic machine photographs of documents, please do send them to us either via email, or if its easier by mail, and we will be happy to publish them.



Ainscough's first crane



The three Ainscough brothers, James, Martin and Brendan with the restored crane

NICE TRIBUTE

The tribute to crane operator Ronnie Jones was a beautiful story and farewell. It made my eyes water-up for a man who truly was Going Up in the World. It shows how decent and respectful most people really are.

Sherm

WHAT NEWS ON THE RAPIER CRANE?

I enjoyed your story on this months Cranes & Access about the old Rapier crane -

page 72 - I just wondered what has happened to it. I have been watching the Vertikal site hoping to see its recovery, I wonder if I have missed it?

Taff Davies

The machine is due to be collected by Emerson Crane Hire and transported to Crowland Cranes for restoration. However there have been some snags and we understand that it is due to be collected in early May. We will follow up and hope to post regular updates on progress.



\$60,00 FOR AUTISM CHARITY

US distributor Fascan and its mini crane partner Jekko raised a least \$60,000 for the Kennedy Krieger Institute autism charity during the recent Conexpo event.

The company sold raffle tickets to win a very special Jekko MPK 20 Mini-Picker crane with a coat of many colours. The crane was won by Snorkel and Xtreme Equipment owner Don Ahern, who might just have bought the most tickets? He also added a very substantial donation to top up the funds raised.

The charity is dear to the heart of Fascan owners Bernie and Michael Faloney, after Michael's son was diagnosed with autism and benefited from the support the charity was able to offer. Its main message philosophy is 'Turning disabilities into abilities.'

Based in the Baltimore-Washington, D.C. region of the USA, the Kennedy Krieger Institute is a not for profit organisation that operates 22 centres and is internationally recognised as having improved the lives and outcomes of tens of thousands of children, adolescents and adults with neurological, rehabilitative or developmental needs through inpatient and day hospital programmes, outpatient clinics, home and community services, education and research. Its website alone is an education and is filled with information on all manner of related issues. www.kennedykrieger.org

You can also donate directly with the following link https://supportus.kennedykrieger.org/site/Donation2?df_id=5340&5340.

donation=form1&mfc_pref=T&s_src=KennedyKrieger.org&s_subsrc=Footer



Don Ahern with the Jekko MPK 20 and the winning ticket

JOIN THE CONVOY TO UKRAINE

Ukraine suffered yet another intense bombardment overnight on Wednesday 8th March. More than 80 Russian missiles were launched at towns and cities across the country, most of them targeting power stations and supply lines. This has only made the situation worse, as Ukrainians struggle to survive on just a few hours of electricity a day, with overnight temperatures that are rarely above freezing.

Help on its way

Even as the attacks were being launched, a truck from the Plant and Hire Aid Alliance was setting off to Ukraine with a 100kVA generator and automatic transfer switches to power the central hospital in Oleksandria, funded by the Concert of Warmth and Light held at Bath Abbey.

The truck also carried five generators from MV Kelly, two generators from Tamdown and a further generator which was kindly donated by a member of the public. It also carried 1,200 litres of oil for the generators donated by Rock Oil.

A long way to go

While we may be approaching the end of harshest winter weather, there is still a long way to go for the people of Ukraine. Generators are still desperately needed to provide the basics of heat, light and power for the homes and shelters of ordinary people. Hospitals, schools and other services are also in dire need of electricity to deliver their vital care.



How you can help

As Russia sends more missiles, the Aid Alliance is working hard to send more generators. It costs just £270 to provide heat, light and power for a Ukrainian family - that's only £216 with Gift Aid. Every donation helps, no matter how large or small, so please give whatever you can.

To make a donation visit the Just Giving page. The Plant and Hire Aid Alliance is run entirely by volunteers, so every penny given will fund generators to be sent directly from the factory to those in desperate need. Thank you, in advance, for your help.

We are also organising another convoy of volunteer vehicles to take humanitarian aid to Kosice in East Slovakia on the 15th and 16th October. This will be our third run so far, the route and channel for distributing aid is now well and truly 'tied and tested' and very straightforward. Those that attended last time had a lot of fun and it was humbling and inspiring to meet so many enthusiastic Ukrainian refugees who unloaded our vehicles.

If anyone would like to participate, please let me know as we'll start to get a list together in the next few weeks.

Best Regards

Jeremy Fish



JOHN W. PARKER 1935-2023

John W. Parker played a major role in the development of the self-propelled scissor lift and has been described as an access industry icon.

He passed away on Thursday, April 6th at the age of 87, and leaves behind his wife Marilyn, daughter Lori and sons Johnny, Robert, David, Mark and Ronnie .

A true pioneer

John Parker began his aerial lift career in May 1966 when he went to work for the A1 Machinery Rental company in Los Angeles, which was owned by Bob Irving. It so happened that Irving purchased his equipment trailers from Selma Trailer in Fresno, which started manufacturing a self-propelled boom lift called the Tree Farmer in the early 1960s, as it attempted to diversify away from cyclical trailer lift market. The machine was improved and refined into the Tree Master in 1965 and Selma's president and owner Carl Ruegg thought that this new improved machine had potential in construction and other markets, and began to sell a few, but quickly realised that to gain real volume it needed to be available to rent.

So, he did the natural thing and approached his best customer - Bob Irving - to see if he would help him develop a rental market for his boom lift. Irving agreed and purchased two units - which were rebranded as Manlift for the construction/industrial market - and Ruegg rented him four more in order to give the trial greater impetus. The machines arrived in A1 Machinery's yard just in time for Parker's first day with the company. Irving told him in no uncertain terms that his sole job was to find out "if these boom lifts... will rent to our customers". Parker was now in the self-propelled aerial lift business.

In order to help him in his endeavours, Parker was given the authority to loan the boom lifts to customers whom he thought would benefit most from using such a machine. He soon discovered that once such a company had used them, they would never go back to their former access methods and would become regular customers. Parker must have made a pretty decent job of it, as during one of Ruegg's follow up visits to check on the programme's progress, Irving asked him if he could convert an old tow-around Sky Witch scissor lift (made by Ditch Witch) into a self-propelled model by equipping it with the drive mechanism from the Manlift booms. Ruegg took the Sky Witch machine back to Selma and did just that, creating what was almost certainly the very first self-propelled scissor lift, which was soon developed into the 25ft Manlift SM31 (Manlift always used working height for its nomenclature).

A move to Manlift

In 1968 Ruegg hired Parker as the Selma Trailer/Manlift international sales manager. Speaking about it a few years later Parker said: "With a title like that I could get a cup of coffee for a dollar anyplace in the country." However, the new job only lasted a year or so, Parker apparently quit at the end June 1969 out of frustration that Ruegg refused to develop or build a smaller scissor lift, on the basis that the cost to manufacture a smaller one would be almost the same as the larger models. When Bob Irving heard that Parker was free, he persuaded him to come back to A1 Machinery Rentals and on listening to his ideas for smaller scissor lifts, agreed to set up a new division/company to design and manufacture them.

Mark Industries is born

Irving named the new business 'Mark Industries', after his son Robert Mark Irving. However, the venture was a form of partnership, so when the first models - 10ft and a 14ft mini scissor lifts - emerged in 1970 they were branded as Parker Lifts. A1 Machinery purchased the very first units - of course. The 10ft model was highly unusual in that it was a three wheeler, which allowed it to turn within its own length, a feature that is much appreciated.

An 18ft model followed in 1972, designed by Nick Hunt and Russ Guthery and Mark Industries became increasingly successful. It later went on to become a global market leader for a time. But everything changed for John Parker in early 1975 when Bob Irving died suddenly, leaving the business to his family. The Irving family attorney quickly brought in a new president to run the company - Rallie Rallis - while Dick Moyer became vice president. John Parker no longer fitted and was fired a couple of months later.

A new beginning

Now out of a job, Parker began reviewing his options, and towards the end

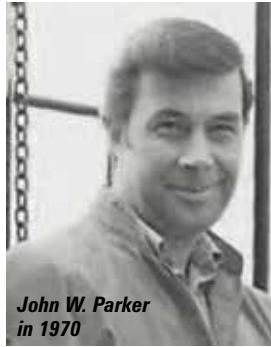

*John W. Parker
in 1970*

1970 - one of the first Parker Lifts, a 10ft 10SP three wheeled model (L-R) Tom Gross, John Parker and Russ Guthery



of the year was approached by Bill Graham of Economy Engineering to design and manufacture a scissor lift that the company could brand and sell alongside its other products. At around the same time Nick Hunt - the engineer from Mark Industries - and four of Mark Industries suppliers approached Parker to set up a new company to build scissor lifts. And that is exactly what they did, establishing John W. Parker and Associates. He and Hunt set up a tiny production facility in Paramount, California - a suburb of Los Angeles - part funded by a \$20,000 deposit/advance from Economy Engineering, with an order for the first 25 units.

HunterLift

Production of the new scissor lifts began in July 1977, but in the intervening period, Economy had hired a former UpRight engineer to design its own scissor lift range. We do not know if they honoured the agreement and took the 25 units, or if Parker simply kept the advance. With no OEM deal on the books, a brand name was required so, when Parker and Hunt's first machines shipped in September of that year, they were branded as HunterLifts, after co-owner Nick Hunt, the Parker Lift name having been left behind with Mark Industries - even though it had switched its product brand to Mark Lift.

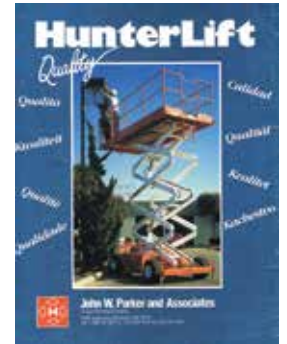

*A HunterLift advert from
the late 1980s*

The HunterLift business really took off in 1982 when it landed an \$800,000 order from Hertz Equipment and then in 1983 the company began building scissor lifts for Calavar/Condor and later teamed up with Frank Delaney in Ireland, who began selling them in large numbers across Scandinavia.

Time to change - the Figgie years

By 1985 the two partners - Hunt and Parker - began to have differences of opinion on how the business should develop and progress, and as a result they decided to sell up and began talking to prospective buyers. The British owned conglomerate Simon, which had become a major player in the powered access market, was the first in the picture. However, Parker's 'acquirer of choice' was Snorkel, which at the time did not have a scissor lift product line.

Parker met with Snorkel president Art Moore at the AED convention and ARA show in early 1987 and a deal was reached soon after, leading to the sale of the HunterLift business to Snorkel's parent company Figgie. While Snorkel chief executive Art Moore had overall responsibility for the HunterLift business, John Parker stayed on as president to run the business as a standalone company within Figgie. With limited capacity at the Paramount plant, he opened a new production facility in nearby Norwalk, California, starting off with 55 employees, many of whom spoke no English, presenting a bit of an issue for Parker, which generated several humorous anecdotes.

Later in 1987 Figgie acquired Economy Engineering - by now a leading scissor lift manufacturer - in spite of strong objections from Art Moore. This complicated the situation, given that all three brands had conflicting dealer networks and was exasperated when Economy was merged into Snorkel. As time went on several of Snorkel's larger distributors become angry that they were being undercut by HunterLift, especially in Scandinavia. John W. Parker and Associates was closed in 1990 as Figgie looked to consolidate the Snorkel, Economy and HunterLift operations into a single streamlined entity/operation. We understand that John Parker continued to work in the aerial lift industry until somewhere around 1996, before retiring properly. In the last two years he and his wife Marilyn moved to the Phoenix, Arizona region.

A true pioneer and icon

There are some who have credited John Parker as the inventor of the scissor lift aerial work platform. This is absolutely not the case, not even close. However, he actually played a much more important role than that, in spotting the potential for smaller self-propelled slab electric scissor lifts, then developing and championing the concept. He was right there at the beginning with Bob Irving and Carl Ruegg, and played a significant role in kicking off the industry as we now know it. He is a true icon of the industry and yet has received very little credit for the important and critical role that he played in the development of the aerial lift industry. Those who knew John Parker well speak highly of him as man and a friend, and he will certainly be missed.

Those of us who have worked in the aerial lift industry owe him a debt of gratitude and what he achieved needs to be more widely recognised. Hopefully this tribute will help bring more attention to that fact.

ROBERT THOMAS 'BOB' FRANCIS 1937 - 2023

UK crane rental man Bob Francis, the founder of Bob Francis Cranes Hire in North Wales, passed away in early April at the age of 85.

Bob Francis, a native Welsh speaker, set up his crane hire company in 1981, formally incorporating the current business the following year. Prior to that he had worked in a variety of jobs, including the police force and even a spell as a private investigator. He was also a successful rally car driver, something he passed on to his son Mark and grandson Luke - who has been particularly successful, winning several competitions.

When Francis started off in the crane rental business he regularly worked 19 hour days, operating cranes such as an eight tonne Hydrocon Marksman and later NCK Pennine crawler cranes. The business expanded in the 1980s on the back of the A55 road development, construction of which began in 1985 with the Conwy Tunnel project, which took more than five years to complete. Bob Francis Crane Hire was appointed as the sole provider of cranes for the project, the work was guaranteed and introduced Francis to 'blue chip' companies, such as the British Nuclear Group.

In an interview with Cranes & Access in 2006 he said: "The geography here is not brilliant, we have fish to the north and sheep to the south and neither of them want cranes! By that time, he had already begun handing over the day to day management of the business to his son Mark, but the process moved up a step when he suffered a stroke in February 2009 from which he managed to bounce back from, with the help of his wife Hefin whom he referred to as "she who must be obeyed."

Bob Francis was one of the UK crane hire industry's real characters, hardworking, honest to the day and a true - larger than life - gentleman. One person who knew him as a customer was Bill Green, who said: "Bob was an entrepreneur of the old school, who believed in hard graft to achieve his objectives, and always enjoyed good company. He will be sadly missed. Rest in peace Bob."

The 2006 interview with Bob Francis can still be viewed online at https://vertikal.net/en/pdf/405/d334af1e/ca_2006_5_p43-44.pdf



Bob Francis with crane operator Neil Roberts and one of his first cranes, a Hydrocon Marksman



Bob Francis at his desk with beloved pipe in hand



Bob Francis in 2006

HANS GEORG E KRAUSE 1937-2023

German access and telehandler sales manager Hans Georg Krause passed away on March 6th at the age of 86, having suffered from ill health over the past few years.

Georg Krause was born in Magdeburg which became part of East Germany after the war but moved away in the 1950s and travelled to the USA where he worked with a number of companies including Sealand and Ford, before moving back to Germany. He spent most of his career in the Cologne area, where he worked with Sony and then chocolate company Stollwerck, he even worked for a film producer in Frankfurt.

His career in the equipment market began, as far as we know, when he started working for JCB Germany in the late 1980s and into the early 1990s. However, he found 'his niche' in the access market when he joined UpRight in April 1994 to manage the company's wholly owned Germany distribution business - Instant Deutschland - a role he fulfilled until he retired. Although retired, he served as a consultant to several companies in the aerial lift business, helping keep busy and his mind active until around 2014, when his much loved wife Gisela sadly passed away, following a long period of illness.

George Krause was a true 'one off'. His former colleagues can and have related numerous anecdotes of 'George being George'. He could talk his way out of almost any situation, no matter how challenging, and it is almost certain that some of the frequent orders he landed were due to customers giving in to his friendly, eloquent but persistent persuasion - you can just imagine them saying: "OK OK where do I sign!"

He was always impeccably dressed and fastidious about everything, from his car to his office, not to the point of being weird, he just had his act together and appreciated precision in almost everything he did.

In his decade or two in the access business he made a great many friends in the industry and kept in touch with many of them long after he had retired. He and Gisela loved to travel and spent a great deal of time in Southern Africa, enjoying trips to Namibia, South Africa and Mozambique.

Georg Krause was a one off, a true character of the German powered access industry of the 1990s and early millennium years. He will be mourned by everyone who knew or worked with him.

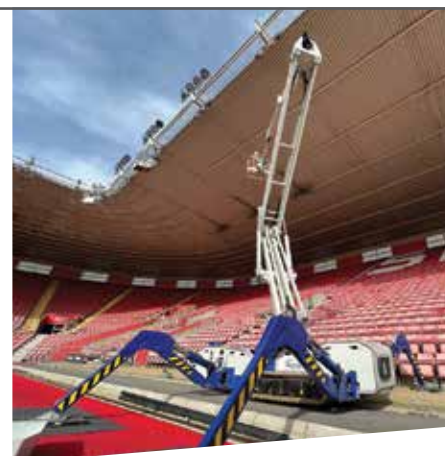

TELESCOPIC AND ARTICULATED SPIDER LIFTS FROM 13 TO 52 METRES

Spider lifts at a higher level for 40 years



falconlifts.com

JDL EXPO A NEW ENERGY!

From 21 to 23 June 2023
in Beaune, France



JDL EXPO: European Exhibition of Equipment for Access Platforms, Handling, Lifting, and Heavy Transport



JDL ENERGY: The first exhibition of alternative energy equipment. JDL ENERGY, is partnering with JDL EXPO this year! Thanks to JDL Energy, come to discover and learn about hybrid, electric, hydrogen, and biofuel technologies and equipment.

Scan QR CODE
or
Get your badge
online:
jdlexpo.com



2023

Samoter

May, 3-7, 2023
International earthmoving and building equipment show Verona, Italy
Tel: +39 045 8298111
www.samoter.it/it

**Vertikal Days 2023**

May 10-11 UK/Ireland Crane, access and telehandler event. East of England showground, Peterborough
Tel: +44 (0) 8448 155900
www.vertikaldays.net

**Innovationstage der Höhenzugangstechnik**

May 16-17 2023
Aerial lift Innovation Days, an informal event for access equipment, cranes & telehandlers
Hohenroda, Hessen Hotel Park, Germany
www.borntolift.de/innovationstag/

**Crane Rental Association of Canada Annual Conference**

May 16-18, 2023
The annual Canadian crane conference
Vancouver, Canada
Tel: +1 780.790.2722
WWW://crac-aclg.ca

**Hire23**

May 24-25, 2023
The annual convention and exhibition of the Hire and Rental Association of Australia and the Elevating Work Platform Association
Sydney, Australia
Tel: +61 (0)2 9998 2255
www.hire21.com.au

**Apex 2023**

June 06-08, 2023
International powered access trade show Maastricht, The Netherlands
Tel: +31 (0)547 271 566
www.apexshow.com

**JDL Expo**

June 22-24, 2023
French cranes and access exhibition/event
Beaune, France
Tel: +33 (0)1 45 63 68 22
www.wjdlexpo.com/

**Platformers' Days 2023**

September 8-9 German access and lifting show Karlsruhe, Germany
Tel: +49 721 3720 5096
www.platformers-days.de

**HCEA International Convention and Old Equipment Exposition**

September 22-24, 2023
The Historical Construction Equipment Association's 37TH annual convention and expo
Bowling Green, Ohio, USA
Tel: +1 785 243 0083
www.hcea.net/page-1492158

**The Utility Expo**

September 26 - 28th 2023
Previously The International Construction & Utility Equipment Exposition / Demo Expo - is the US utility industry's largest show
Louisville, Kentucky, USA
Tel: +1 414-274-0644
www.theutilityexpo.com

**GIS 2023**

October 05-07, 2023
Italian crane, access and heavy transport exhibition Piacenza, Italy
Tel: +39 010/5704948
www.gisexpo.it

**CICA National Conference 2023**

October 26 - 28 2023
The annual conference of the Crane Industry Council of Australia
Perth - Western, Australia
Tel: +61 03 8320 0411
www.conference.cica.com.au

**Liftex conference**

November 21-22, 2023
Annual conference of LEEA Lifting Equipment Engineers Association
Liverpool, UK
Tel: +44 203 488 2865
www.liftex.org/

**Smopyc 2023**

November 22-25, 2023
Spanish construction equipment exhibition Zaragoza, Spain
Tel: +34 976 764 700
www.feriazaragoza.com/smopyc

**2024****Swissbau**

16-19th January 2024
Swiss construction exhibition Basel, Switzerland
Tel: +41 58 200 20 20
www.swissbau.ch

**The ARA Show 2024**

February 18-21, 2024
The American Rental Association's annual trade show and convention
New Orleans, Louisiana, USA
Tel: +1800 334 2177
http://www.arashow.org/

**Mawev 2024**

April 10-14, 2024
Austrian construction exhibition
St. Pölten, Austria
Tel: +43 316 8088 216
www.mcg.at/events/mawevshow

**SC&RA Annual Conference**

April 15-19, 2024
Annual Conference of the US cranes and heavy transport association including the Jobs of the Year awards
Omni Barton Creek, Austin, Texas, USA
Tel: Tel: +1(703) 698-0291
www.scranet.org/SCRA/Events

**Hanover Messe**

April 22 - April 26
World's largest industrial exhibition Hanover, Germany
Tel: +49 511 89-1
www.hannovermesse.de

**Intermat 2024**

April 22-27 2024
The big French international construction equipment show
Paris, France
+33 (0)1 76 77 15 21
www.paris.intermatconstruction.com

**The IPAF Summit and awards 2024**

Annual Summit and IAPAs awards ceremony of the International Powered Access Federation Berlin
Tel: +44(0)15395 66700
www.ipaf.org

**Bauma China 2024**

November 26-29, 2024
bauma in Shanghai Shanghai, China
Tel: +49(0)89 9 4920251
Fax: +49 (0)89 9 4920259
www.bauma-china.com/

**Bauma Conexpo India**

December 11-14 2024
Preliminary dates for the bauma/Conexpo exhibition in India
Noida, Delhi, India
Tel: +49 89 949-20255
www.bcindia.com/en/

**2025****Baumag**

January 26-29, 2025 Swiss construction equipment show Lucerne, Switzerland
Tel: +41 56 204 20 20
www.baumaschinen-messe.ch/htm/home.htm

**Bauma 2025**

January 23-26 2025
World's largest construction equipment show Munich, Germany
Tel: +49 (0)89 51070
www.bauma.de/index-2.html

**2026****The ARA Show 2026**

February - Dates to be confirmed
The American Rental Association's annual conference and exhibition
Orlando, Florida, USA
Tel: +1800 334 2177
www.arashow.org

**Conexpo-Con/Agg 2026**

March 03-07, 2026
The leading US construction show
Las Vegas, Nevada, USA
Tel: +1 414-298-4133
www.conexpoconagg.com



Visit: www.Vertikal.net/en/events for a full listing of events with direct links to the organisers.

Vertikal days

CRANES, ACCESS PLATFORMS, TELEHANDLERS
& EVERYTHING IN BETWEEN

BOOK NOW

East of England Showground, Peterborough

10th - 11th May
2023
www.vertikaldays.net

MARKETPLACE

RECRUITMENT . USED EQUIPMENT . REPLACEMENT PARTS

Place your products or services in front of more than 26,000 individuals who buy, specify or use cranes, lifting gear, aerial work platforms, work at height equipment or telehandlers across 195 countries. Given the global readership you may be surprised at how little a regular advert costs and how effective it can be.

www.vertikal.net/en/cranes-and-access/advertise

The Vertikal Press Ltd

advertising@vertikal.net or info@vertikal.net

Contact us at:

cranes & access



The Vertikal Press Ltd.

PO Box 6998, Brackley,
NN13 5WY UK.
Tel: +44 (0)8448 155900
E: advertising@vertikal.net

Vertikal Verlag

Sundgauallee 15, Freiburg
Germany, D-79114
Tel: +49 (0)761 8978660
E: info@vertikal.net



FIND THAT PERSON



LOOKING FOR CRANE, ACCESS OR TELEHANDLER PEOPLE? LOOKING FOR A JOB?

Then why not start right here in the Cranes&Access recruitment section? With your support we can build a highly useful recruitment resource for the industry right within the UK and Ireland's only dedicated publication.

Call or email us today to find out about our great start up rates. Jobs Wanted ads are FREE!

+44 (0) 8448 155900

If responding to one of the ads please say you saw it in Cranes&Access.

**cranes
&access**

**Vertikal
.net**

Trainee journalist WANTED

Cranes & Access/Vertikal.net is looking for a young addition to its editorial team. No previous experience is required but you should have a bright enquiring and questioning mind and an interest in how things work.

Job location would be South Northamptonshire

Please send a CV in the first instance to editor@vertikal.net

MOBILE CRAWLER CRANE ENGINEER

Job Posting - Mobile Crawler Crane Engineer

Set up in 2014 Hawks have built up an strong reputation for providing a quality service within the UK lifting industry, predominately hiring and selling crawler cranes. Hawks prides itself on a culture with a strong family ethos, which the Founder is very keen on maintaining and nuturing within the business.

We are currently looking for a full-time Mobile Crawler Crane Engineer to maintain, rig and provide breakdown assistance to a fleet of crawler cranes ranging from 25t to 300t, both with lattice and telescopic type jibs. The role will primarily be based from our Dartford depot with 70% of the cranes on hire in or around the London area, but will require infrequent travel to sites across the UK.

A preference would be for candidates to have 3+ years experience of working with either mobile, crawler cranes or any other similar type of cranes. Our fleet consists of Kobelco and Liebherr (LR and LTR) cranes. Experience in maintaining these types of cranes or Liebherr LTM cranes would be preferred, but not essential. You will need to have a minimum (or equivalent) level 2 NVQ in plant mechanics, with a deep understanding and knowledge in electrics, hydraulics, mechanics and CAMBUS systems.

If you have the experience and attributes to meet the requirements above and you are passionate about your career within the lifting industry, please email a CV to hr@hawkshire.com.

T: 01474 703187 (Option 1)
E: hr@hawkshire.com
W: www.hawkshire.com



**cranes
& access**

Get the
whole story...

...follow us on

facebook

twitter

Linked in

Vertical
.net

**GLAD
2023**

SAVE THE DATE!

Global Lifting Awareness Day
Thursday 13 July

Join LEEA and other stakeholders in raising awareness of the lifting industry.

Use the Hashtag #GLAD2023

globalliftingawarenessday.com



C&A Access & Lifting directory

The fast and efficient way to find a supplier

Reach over 28,000 readers for only £185/€210 per year with live link direct to your website. Check out the new enhanced entry option!

Book now – advertising@vertikal.net

ACCESS EQUIPMENT MANUFACTURERS

AIRO	www.airo.com
Alimak	www.alimak.com
Almac	www.almac-italia.com
ATN	www.atnplatforms.com
Böcker	www.boecker.de
Bravi	www.braviisol.com
Bronto Skylift	www.brontoskylift.com
CLM Construction Supplies	www.clm-supplies.com
CMC	www.cmclift.com
CPL	www.cumberlanduk.co.uk
CTE	www.ctelift.com
Denka-Lift	www.rothlehner.com
Dino Lift	www.dinolift.com
Dingli	www.cndingli.com
Easylift	www.easy-lift.it
Falcon Lifts	www.falconlifts.com
GEDA	www.geda.de
Genie	www.genielift.com
GSR	www.gsrspa.it
Haulotte	www.haulotte.com
Hinowa	www.hinowa.com
Holland Lift	www.hollandlift.com
Imer Access	www.imergroup.com
Iteco	www.imergroup.com
JCB	www.jcb.com
JLG	www.jlg.com
Klaas	www.klaas.com
Klubb France	www.klubb-france.fr
Leguan Lifts	www.leguanlifts.com
Manitou Group	www.manitou.com
Omme Lift	www.ommelift.com
Palazzani Industrie	www.palazzani.it
Palfinger Platforms	www.palfinger-platforms.com
Platform Basket	www.platformbasket.com

Ruthmann	www.ruthmann.de
Sinoboom	www.sinoboom.com
Saeclimber	www.saeclimber.com
Skyjack	www.skyjack.com
Snorkel	www.snorkellifts.com
Socage	www.socage.it
Teupen	www.teupen.com
Versalift UK	www.versalift.co.uk
Zoomlion	http://en.zoomlion.com

PLATFORM RENTAL

AA Access (Specialists)	www.aaaccess.co.uk
Acrolift	www.acrolift.co.uk
Ahern Rentals - USA	www.ahern.com
AFI- Uplift	www.afi-uplift.co.uk
Dragon Access	www.dragon-access.co.uk
Drammen Liftutleie AS	www.drammenlift.no
Hird	www.hird.co.uk
JMS Powered Access	https://jms.co.uk
Kran Cranes Rental Romania	www.kran.ro/inchiriere-macara-constant
Monitor Lifts - AUS	www.monitor.net.au
Mr Plant Hire	www.mrplanthire.co.uk
Platform Sales & Hire	www.platformsales.co.uk
Power Platform Services	www.pps.co.uk
Rapid Platforms	www.rapidplatforms.co.uk
Warren Access	www.warrenaccess.co.uk

NEW & USED PLATFORMS

Access Platform Sales (APS)	www.accessplatforms.co.uk
AFI Resale	www.afi-resale.co.uk
A.J. Access Platforms	www.accessplatforms.com
Gantic, Norway	www.gantic.no
Genie	www.genielift.com
GSR Aerial Platforms UK	http://en.gsrspa.it
Haulotte	www.haulotte.com
Hird	www.hird.co.uk

Independent Access Sales	www.iasales.co.uk
International Platforms	www.internationalplatforms.co.uk
INTEQ UK and UAE	www.inteq.uk
JLG	www.jlg.com
JMS Powered Access	https://jms.co.uk
Kunze GmbH	www.kunze-buehnen.com
Mr Plant Hire	www.mrplanthire.co.uk
Rothlehner	www.rothlehner.com
Platform Sales	www.platformsales.co.uk
Promax Access	www.promaxaccess.com
Rapid Platforms	www.rapidplatforms.co.uk
TVH - Group	www.tvh.com
Vertimac	www.vertimac.com

CRANE MANUFACTURERS

Böcker	www.boecker.de
Ernest Doe & Sons Ltd.	www.ernestdoelockeranes.com
Grove	www.grovetworldwide.com
Jaso Tower Cranes	https://jaso.com
Jekko Minicrane	www.jekko.it
JMG	www.jmgcranes.com
KATO	www.rivertekservices.com
Klaas	www.klaas.com
Kobelco	www.kobelcocm-global.com
Liebherr	www.Liebherr.com
Linden Comansa	www.comansa.com
Maeda	www.maedaminicranes.co.uk
Manitowoc	www.manitowoccranes.com
Potain	www.manitowoccranes.com
Raimondi	www.raimondi.com
Spierings	www.spieringskranen.nl
Tadano	www.tadano.com
Tadano Faun	www.tadano.com
Tadano Demag	www.demagmobilecranes.com
Unic Cranes	www.unic-cranes.co.uk
Valla	www.valla-cranes.co.uk
Wolffkran	www.wolffkran.de
Zoomlion	www.zoomlioncranes.co.uk

LORRY/TRUCK LOADER CRANES

Atlas Cranes UK	www.atlasgmbh.com
Ernest Doe & Sons Ltd.	www.ernestdoelockeranes.com
Palfinger	www.palfinger.com

NEW & USED CRANES

Cotac Oy	www.crane.fi
Crowland Cranes	www.crowlandcranes.co.uk
Delden Cranes	www.deldencranes.co.uk
Ernest Doe & Sons Ltd.	www.ernestdoelockeranes.com
Gantic, Norway	www.gantic.no
HighSparks	www.highsparks.co.uk
Hird	www.hird.co.uk
Kobelco	www.kobelco-cranes.com
Rivertek Services	www.rivertekservices.com
Terex Demag	www.terex-cranes.com
Valla	https://valla-cranes.co.uk

CRANE HIRE

Cadman Cranes	www.cadmancranes.com
Cork Crane Hire (Liverpool)	www.corkcranehire.com
Delden Cranes	www.deldencranes.co.uk
HighSparks	www.highsparks.co.uk
Hovago	www.hovago.com
John Sutch Cranes	www.johnsutchcranes.co.uk
Kran Cranes Rental Romania	www.kran.ro/inchiriere-macara-constant
Ladybird Tower Crane Hire	www.ladybirdcranehire.co.uk
McNally Crane Hire	www.cranehire-ireland.com
Sangwin	www.sangwin.co.uk
Schaften Leasing B.V.	www.schaftenleasing.nl

MINI CRANE HIRE

GGR	www.unic-cranes.co.uk
JT Mini Crane Hire	www.jtminicranes.co.uk
Lift Limited	www.liftminicranehire.co.uk
Hird	www.hird.co.uk

SELF ERECTING TOWER CRANES

Cork Crane Hire	www.corkcranehire.com
John Sutch Cranes	www.johnsutchcranes.co.uk
Ladybird Tower Crane Hire	www.ladybirdcranehire.co.uk

TOWER CRANES

HighSparks	www.highsparks.co.uk
------------	--

FURNITURE HOISTS

Böcker	www.boecker.de
--------	--

TELEHANDLER MANUFACTURERS

Dieci Telehandlers Ltd	www.dieci-telehandlers.co.uk
Faresin	www.faresindustries.com
Genie	www.genielift.com
Haulotte	www.haulotte.com
JLG	www.jlg.com
Magni	www.magnith.com
Manitou Group	www.manitou.com
Skyjack	www.skyjack.com
Snorkel	www.snorkellifts.com
Merlo	www.merlo.co.uk

NEW & USED TELEHANDLERS

Dieci Telehandlers	www.dieci.com
Gantic, Norway	www.gantic.no
GT Lifting Solutions	www.gtlift.co.uk
TVH Group	www.tvh.com
Vertimac	www.vertimac.com

TELEHANDLER RENTAL

GT Lifting Solutions	www.gtliftingltd.co.uk
JMS Powered Access	https://jms.co.uk
Mr Plant Hire	www.mrplanthire.co.uk

SCAFFOLD TOWERS

CLM Construction Supplies	www.clm-supplies.com
---------------------------	--

MASTCLIMBERS & HOISTS

Alimak	www.alimak.com
CLM Construction Supplies	www.clm-supplies.com
GEDA	www.geda.de
Klaas	www.klaas.com
Saeclimber	www.saeclimber.com

SPECIAL/BESPOKE ACCESS & LIFTING SOLUTIONS

Access Platform Sales (APS)	www.accessplatforms.co.uk
GT Lifting Solutions	www.gtliftingltd.co.uk
JMS Powered Access	https://jms.co.uk
Platform Sales & Hire	www.platformsales.co.uk
Warren Access	www.warrenaccess.co.uk/hire
Working At Height Ltd	www.workingatheightltd.com

SPECIAL & NICHE ACCESS

Acrolift	www.acrolift.co.uk
DENKA Narrow	www.rothlehner.com
JMS Powered Access	https://jms.co.uk
Rapid Platforms	www.rapidplatforms.co.uk
Smart Platform Rentals	www.smartplatforms.co.uk

SPECIAL LIFT & TRANSPORT EQUIPMENT

Collett A Sons, UK	www.collett.co.uk
--------------------	--

HEAVY TRANSPORT/ABNORMAL LOADS

Collett A Sons, UK	www.collett.co.uk
--------------------	--

SELF-PROPELLED MODULAR TRANSPORTERS

Collett & Sons, UK	www.collett.co.uk
--------------------	--

SITE SAFETY AUDITS

Alfa Access Services	www.alfa-access-services.com
----------------------	--

INDUSTRY ASSOCIATIONS

ALLMI	www.allmi.com
CICA	www.cica.com.au/
CISRS	www.cisrs.org.uk
CPA	www.cpa.uk.net
EWPA	www.ewpa.com.au
IPAF	www.ipaf.org
NASC	www.nasc.org.uk
OSHA	www.osha.gov
PASMA	www.pasma.co.uk

HEAVY LIFT MANAGEMENT

DWLS	www.dwls.co.uk
------	--

HEAVY LIFT PLANNING & RISK ANALYSIS

DWLS	www.dwls.com
------	--

AUCTION HOUSES

Ritchie Brothers	www.rbaction.com
------------------	--

BATTERY SUPPLIERS & MANUFACTURERS

Battery Service Hub	www.batteryservicehub.com
DC Battery Technologies	www.dcbattery.tech
Leoch Battery UK	www.leochbattery.co.uk
Platinum International Ltd	Platinuminternational.co.uk

LOAD CELLS & LOAD MONITORING SYSTEMS

PCE Instruments UK Ltd	www.pce-instruments.com
------------------------	--

CONTROL SYSTEMS

MOBA Automation	www.moba.de
-----------------	--

GENERATOR SALES & RENTAL

JMS Powered Access	https://jms.co.uk
--------------------	---

ONLINE TECHNICAL HELP

Crane Tools	www.cranetools.com
-------------	--

OUTRIGGER PADS, MATS & ROADWAYS

Brilliant Ideas / Alimats	https://brilliantideasltd.co.uk/alimats/
DAWSON-WAM Steel Mat Hire	www.SteelMatHire.co.uk
Mat & Timber Services	www.sarumhardwood.co.uk
Nolim	www.nolim.co.uk
Outriggerpads	www.outriggerpads.co.uk
Timbermat	www.timbermat.co.uk
TMC lifting supplies	www.tmc-lifting.com
Universal Crane Mats	www.universal-crane-mats.com
Welex Group	www.welexgroup.com

COMPONENT SUPPLIERS

PCE Instruments UK Ltd	www.pce-instruments.com
Tele Radio Group	www.tele-radio.com

WIRE ROPE & CABLE

Rope and Sling	www.ropeandsling.co.uk
----------------	--

LIFTING GEAR MANUFACTURERS

Britlift	www.britlift.com
----------	--

PARTS & SERVICE SUPPLIERS

Alfa Access Services	www.alfa-access-services.com
Crowland Cranes	www.crowlandcranes.co.uk
Ernest Doe & Sons Ltd.	www.ernestdoeladecranes.com
Gantic, Norway	www.gantic.no
Haulotte	www.haulotte.com
IPS	www.ipspartsonline.com
JLG	www.jlg.com
Lift-Manager	www.lift-manager.com
OTR Wheel Engineering Europe	www.otrwheel.co.uk
PCE Instruments UK Ltd	www.pce-instruments.com

TVH - Group Thermote & Vanhalst	www.tvh.be
---------------------------------	--

Vertimac	www.vertimac.com
----------	--

RECRUITMENT

Vertikal.Net	www.vertikal.net/en/recruitment
--------------	--

SAFETY EQUIPMENT

Load Systems UK Ltd	www.loadsystems.co.uk
---------------------	--

RENTAL MANAGEMENT SOFTWARE

Higher Concept	www.higherconcept.co.uk
HireHop Equipment Rental Software	www.hirehop.co.uk
HireHop Equipment Rental Software	www.hirehop.com
Infosystem	www.levaplus.ch
insPHire	www.insphire.com
Matusch GmbH	www.matusch.de
MCS Rental Software	www.mcsrentalsoftware.com
vWork	www.vworkapp.com

STRUCTURAL REPAIRS

Crowland Cranes	www.crowlandcranes.co.uk
John Taylor Crane Services	www.jtcranes.co.uk

TRAFFIC MANAGEMENT

Atlas Traffic Management	www.atlastm.co.uk
--------------------------	--

TECHNICAL & SAFETY CONSULTANCY

Access Safety Management	www.accesssafety.co.uk
--------------------------	--

TRAINING ASSOCIATIONS & NETWORKS

ALLMI	www.allmi.com
AWPT	www.awpt.org
IPAF	www.ipaf.org
NASC	www.nasc.org.uk
Pasma	www.pasma.co.uk

TRAINING CENTRES & TRAINERS

Access Platform Sales (APS)	www.accessplatforms.co.uk
Astra Access	www.astratraining.co.uk
Ainscough	www.ainscoughtraining.co.uk
AJ Access	www.accessplatforms.com
Boss Training	www.bosstraining.co.uk
Centora Training	centoratraining.co.uk
Haulotte	www.haulotte.com
IAPS	www.iapsgroup.com
Lift-Manager	www.lift-manager.com
Smart Platform Rentals	www.smartplatforms.com
TVH Group	www.tvh.com
UTN	www.utntraining.co.uk
Versalift Training Direct	www.versalift.co.uk/training
Warren	www.warrenaccesstraining.co.uk/courses/Access Training

SAFETY TRAINING

Atlas Cranes UK	www.atlasgmbh.com
-----------------	--

TRAINING SERVICES

JLG Training	www.jlg.com
Liebherr Training (UK)	www.liebherr.co.uk
Lifting Equipment Training	www.lettd.co.uk
Mentor Training	www.mentortraining.co.uk
Mr Plant Hire	www.mrplanthire.co.uk
Rapid Platforms	www.rapidplatforms.co.uk
TH White	www.thwhite.co.uk
Terex Atlas (UK) Ltd.	www.atlascranes.co.uk
TVH Group	www.tvh.com

ARE YOU LISTED...
...in C&A's NEW
Access & Lifting
directory?



REVISTA TÉCNICA MÁS
LEIDA DE HABLA HISPANA
www.movicarga.com

MOVICARGA

MOVIMIENTO DE CARGAS

**¿QUIERES
DAR LA
MÁXIMA
COBERTURA
A TUS
NOTICIAS?**

info@movicarga.com

21,560
contactos en

LinkedIn

SAFETY FIRST... ALWAYS



IN STOCK

NOLIM OUTRIGGER PADS
ARE BUILT TO LAST

Call us on **01480 891 251** or email parts@accessplatforms.co.uk

Access Platform Sales Ltd - Leewood Business Park, Upton, Huntingdon, Cambridgeshire. PE28 5YQ



EXTRA! EXTRA!
JOIN HCEA
TODAY!

READ ALL ABOUT IT!

Join the Historical Construction Equipment Association (a non-profit organization) and receive its quarterly magazine, *Equipment Echoes*. Read fascinating articles about all types of old construction equipment, illustrated by beautiful historic photos.

That's not all we do! We also feature:
International Convention & Old Equipment Exposition

Held annually and featuring working demonstrations and static displays.

National Construction Equipment Museum and Archives

A world-renowned collection, open to the public, of everything from fully restored antique machinery to 1800s literature and photographs.



It's only \$35 US per year in the USA and Canada, \$55 US all others. To join, call us at 419-352-5616, or mail a check or money order to HCEA, 16623 Liberty Hi Road, Bowling Green, Ohio 43402.

Join online and learn more about us at www.hcea.net.

Thank you for your interest and support!



KRAN & BÜHNE
Das Magazin für Kran- & Arbeitsbühnen-Anwender

Ihr Vorteil!



Um leistungs- und wettbewerbsfähig zu bleiben, benötigt die Industrie hochqualifizierte und ihre Märkte betreffende Informationen. Diesem Verlangen kommt *Kran & Bühne* mit praxisorientierten Artikeln nach. Mit unseren Publikationen helfen wir den Lesern, gerade bei härteren Marktbedingungen, fundierte Entscheidungen zu treffen. Die Artikel werden von einem erfahrenen, international und in Deutschland tätigen Journalistenteam verfasst. *Kran & Bühne* liefert dem Leser Neuigkeiten und Baustellenberichte. Ein wichtiger Bestandteil sind dabei harte Fakten darüber, welche Ausrüstung für welche Einsätze geeignet ist.

Abonnieren Sie jetzt einfach & bequem!
Per Fax: (07 61) 88 66 814
oder per Post: Kran & Bühne | Sundgaullee 15 | D-79114 Freiburg
Tel. (07 61) 89 78 66-0 | Fax (07 61) 88 66 814 | E-Mail: info@Vertikal.net | www.Vertikal.net

» Ich wünsche folgende Zahlungsweise:

Bargeldlos per Bankeinzug (nur in Deutschland) gegen Rechnung

» IBAN:
» BIC:
» Geldinstitut:
» Firma:
» Postleitzahl/Ort:

Hiermit bestätige ich, dass die Abbuchung des jährlichen Abo-Betrages von 26,- Euro für o.g. Firma/Anschrift vorgenommen werden kann.

» 2. Unterschrift des Abonnenten:

Widerrufsgarantie: Das Abonnement kann jederzeit und ohne Angabe eines Grundes widerrufen werden. Die Kosten für nicht zugestellte Ausgaben werden zurückerstattet.



SUBSCRIBE TO THE
C&A NEWS PACKAGE
AND GET THE
INDUSTRY'S MOST
WIDELY READ NEWS

Vertikal.net   

To get your **SUBSCRIPTION** up and running register online at www.vertikal.net/en/subscriptions



EVERY ISSUE
Delivered to your door

PLUS

DIGITAL ISSUE
Online

YEARLY SUBSCRIPTION

<p>£40.00/€60.00 (UK and Ireland)</p> <p>€75.00 (Rest of Europe)</p>	<p>\$110.00/£60.00 (Other regions)</p> <p>Payable by BACS transfer/ credit card/cheque</p>
--	--

AN INDEPENDENT NEWS SERVICE COSTS MONEY AND NEEDS YOUR SUPPORT SUBSCRIBE TODAY!



vertimac
access equipment **parts**

ACCESS, OUR WORLD



“ Vertimac cordially invites you to the world’s leading access equipment event. ”



*Caroline De Cock,
Sales*

MEET US AT STAND 440

More information?

- **Parts** + 32 56 612 666 ■ parts@vertimac.com
- **Machines** + 32 56 772 666 ■ sales@vertimac.com

  
www.vertimac.com

REGISTER HERE



TAILORED FOR RENTAL

- High quality nano electrophoretic paint technology
- World class components you know and trust
- Full range indoor and outdoor use
- Fully open platform gate
- Bumper rails

Vertical
days

2023
MAASTRICHT
10-11-12
6-8 JUNE

LEARN MORE AT [SINOBOOM.EU](https://www.sinoboom.eu)

SINOBOOM™

PARTNERS IN ACCESS™